

## **4M CMOS Camera**

**ID4MB-CL (B/W)**

**ID4MC-CL (Color)**

# **Technical Manual**

---

---

## Table of Contents

	PAGE
1. <b>Product Outline</b> .....	3
2. <b>Handling Precautions</b> .....	3
3. <b>Specification</b> .....	4
3.1. General Specification.....	4
3.2. Camera Output Signal Specification .....	5
3.3. Spectral Response (Representative Value).....	6
4. <b>Connector</b> .....	7
4.1. Camera Link Connector 12226-1100-00PL (SUMITOMO 3M).....	7
4.2. Power LED .....	7
5. <b>Timing Chart</b> .....	8
5.1. Horizontal Synchronous Signals Timing (2Tap Base Configuration : 38fps ) .....	8
5.2. Vertical Synchronous Signals Timing (2Tap Base Configuration : 38fps).....	8
5.3. Horizontal Synchronous Signals Timing (4Tap Medium Configuration : 75fps).....	9
5.4. Horizontal Synchronous Signals Timing (2Tap Base Configuration Center Trimming 1024(H)) .....	9
5.5. Vertical Synchronous Signals Timing (4Tap Medium Configuration : 75fps).....	10
5.6. Horizontal Synchronous Signals Timing (8Tap Full Configuration : 150fps) .....	11
5.7. Horizontal Synchronous Signals Timing (2Tap Base Configuration Center Trimming 512(H)).....	11
5.8. Vertical Synchronous Signals Timing (8Tap Full Configuration : 150fps) .....	12
5.9. Video Output Format.....	13
5.10. Fixed Trigger Shutter Mode .....	15
5.11. Pulse Width Trigger Shutter Mode.....	16
6. <b>Center Trimming Mode</b> .....	17
7. <b>Partial Scan Mode</b> .....	18
8. <b>Remote Communication</b> .....	20
8.1. Command Specifications.....	21
8.2. Control Example .....	25
9. <b>Function Setting</b> .....	29
10. <b>CMOS Optical Axis Accuracy</b> .....	32
11. <b>Dimensions</b> .....	33
12. <b>Initial Setting</b> .....	34
13. <b>Cases for Indemnity (Limited Warranty)</b> .....	35
14. <b>CMOS Pixel Defect</b> .....	35
15. <b>Product Support</b> .....	35

---

---

## 1. Product Outline

ID4MB-CL/ID4MC-CL is a Camera Link (PoCL) interfaced and 4M resolution camera module. 4M pixels CMOS sensor with diagonal length 15.930mm is utilized. Entire pixels can be read out within 1/75s at Medium Configuration output.

### Features

- Global Shutter CMOS sensor is utilized.
- Camera Link (PoCL) Base , Medium, Full Configuration are supported.
- Fixed trigger shutter mode, pulse width trigger shutter mode are operable.
- Full frame rates are as follows.

2Tap Base Configuration	38fps	8bit/10bit
4Tap Medium Configuration*	75fps	8bit/10bit
8Tap Full Configuration	150fps	8bit

\*Initial Setting
- Center Trimming Output Mode

2Tap Base Configuration Center Trimming 1024(H)	149fps	8bit/10bit	Partial Scan 1024(V)
2Tap Base Configuration Center Trimming 512(H)	587fps	8bit	Partial Scan 512(V)

## 2. Handling Precautions

The camera must not be used for any nuclear equipment or aerospace equipment with which mechanical failure or malfunction could result in serious bodily injury or loss of human life. Our warranty does not apply to damages or defects caused by irregular and /or abnormal use of the product.

Please observe all warnings and cautions stated below.

Our warranty does not apply to damages or malfunctions caused by neglecting these precautions.

Do not use or store the camera in the following extreme conditions :

- Extremely dusty or humid places.
  - Extremely hot or cold places (operating temperature -5°C to +45°C).
  - Close to generators of powerful electromagnetic radiation such as radio or TV transmitters.
  - Places subject to fluorescent light reflections.
  - Places subject to unstable (flickering, etc.) lighting conditions.
  - Places subject to strong vibration.
- 
- Remove dust or dirt on the surface of the lens with a blower.
  - Do not apply excessive force or static electricity that could damage the camera.
  - Do not shoot direct images that are extremely bright (e.g., light source, sun, etc.), and when camera is not in use, put the lens cap on.
  - Confirm the mutual ground potential carefully and then connect the camera to monitors or computers. AC leaks from the connected devices may cause damages or destroy the camera.
  - Do not apply excessive voltage. (Use only the specified voltage.) Unstable or improper power supply voltage may cause damages or malfunction of the camera.
  - The voltage ripple of camera power DC +12V±10% shall be within ±50mV. Improper power supply voltage may cause noises on the video signals.
  - The rising time of camera power supply voltage shall be less than +10V, Max 60ms. Please avoid noises like chattering when rising.

### 3. Specification

#### 3.1. General Specification

(1) Image Sensor	Type	Diagonal length 15.930mm, Global Shutter (CMOSIS CMV4000)	
	Effective Pixel Number	2048(H) x 2048(V)	
	Cell Size	5.5μm(H) x 5.5μm(V)	
	Image Circle	Φ15.930mm	
(2) Video Output Frequency	Pixel Clock	80MHz	
	Output Effective Pixel number	2048(H) x 2048(V)	
	2Tap Base Configuration	38fps	1032(H) x 2064(V) with Blanking
	4Tap Medium Configuration	75fps	516(H) x 2064(V) with Blanking
	8Tap Full Configuration	150fps	258(H) x 2064(V) with Blanking
	2Tap Base Configuration Center Trimming 1024(H)	149fps	516(H) x 1040(V) with Blanking 1024(H) x 1024(V)
(3) Video Output	2Tap Base Configuration	587fps	258(H) x 528(V) with Blanking 512(H) x 512(V)
(4) Output Format	Sensor AD	10bit	
	Camera Link	8bit / 10bit (Fixed to 8bit at Full Configuration mode)	
	8Tap Full Configuration		
(5) Sensitivity	B/W	F8.0	2000lx
	Color	F5.6	2000lx
(at shutter speed 1/75s(OFF), Gain 0dB, Medium Configuration mode)			
(6) Minimum Illumination	B/W	F1.4	3.0lx
	Color	F1.4	30.0lx
(at shutter speed 1/75s(OFF), Gain +12dB, Medium Configuration mode)			
(7) Power Requirements	DC+12±10%PoCL		
(8) Power Consumption	typ 2.0W (at 4Tap Medium Configuration)		
	max 2.5W (at 8Tap Full Configuration)		

(9) Dimensions	H:29mm W:29mm D:43mm excluding projection	
(10) Weight	Approx. 75g	
(11) Lens Mount	C Mount ID4MC-CL(Color) : IR cut filter	
(12) Optical Axis Accuracy	Refer to drawing for CMOS optical axis accuracy	
(13) Gain Variable Range	0dB ~ +12dB (Guaranteed range)	
(14) Shutter Speed Variable Range	2Tap Base Configuration	OFF(1/38s) ~ 1/30000s
	4Tap Medium Configuration	OFF(1/75s) ~ 1/40000s
	8Tap Full Configuration	OFF(1/150s) ~ 1/50000s
	2Tap Base Configuration Center Trimming 1024(H)	OFF(1/75s) ~ 1/40000s
	2Tap Base Configuration Center Trimming 512(H)	OFF(1/150s) ~ 1/50000s
(15) Trigger Shutter Mode	Fixed Trigger Shutter Mode, Pulse Width Shutter Trigger Mode	
(16) Partial Scan	B/W	Full Frame ~ 1Line (1Line/step)
	Color	Full Frame ~ <b>2Line (2Line/step)</b>
(17) Safety/Quality Standards	UL : Conform to UL Standard including materials and others.	
	CE : To be applied for EN55022:2006 Class B for Emission 06 To be applied for EN61000-6-2:2005 for Immunity	
	RoHS : Conform to RoHS	
(18) Durability	Vibration 20~200 Hz, 98m/s <sup>2</sup> (10G), X,Y and Z directions (120 min for each direction)	
	Shock No malfunction shall be occurred with 980m/s <sup>2</sup> (100G) for ±X,±Y,±Z, 6 directions. (without package)	
(19) Operation Environment	Temperature -5 ~ +45°C Humidity 20 ~ 80%RH with no condensation.	
(20) Storage Environment	Temperature -25 ~ +60°C Humidity 20 ~ 80%RH with no condensation.	

### 3.2. Camera Output Signal Specification

(1)Video Output Data	Effective Video Output	2048(H) × 2048(V)	(at Full Frame Scan Mode)
(2)Sync Signal Output	LVAL FVAL DVAL SP	Camera Link (LVDS)	
(3)Camera Control Signal Input	CC2·CC3·CC4	Camera Link (LVDS)	
(4)Trigger Input	Polarity	Positive/Negative Selectable (Address 05)	
	Pulse Width	1HD(Min) ~ Approx.2 frames ·2Tap Base Configuration : 1HD (12.9us) ·4Tap Medium Configuration : 1HD (6.45us) ·8Tap Full Configuration : 1HD (3.225us) ·2Tap Base Configuration Center Trimming 1024(H) : 1HD (6.45us) ·2Tap Base Configuration Center Trimming 512(H) : 1HD (3.225us) Functionally, no upper limitation is set but noises such as dark noises and shadings might be noticeable at long time exposure.	
	CC1(Trigger Input)	Camera Link (LVDS)	
(5)Serial Communication	SerTC (Serial to Camera) SerTFG (Serial to Frame Grabber)	Camera Link (LVDS)	
(6)Video Signals	White Clip Level	3FFh	(at Gain 0dB, 10bit)
	Setup Level	under 002h	
	Dark Shading	Both horizontal and vertical should be under 00Fh	

3.3. Spectral Response (Representative Value)

ID4MB-CL (B/W)

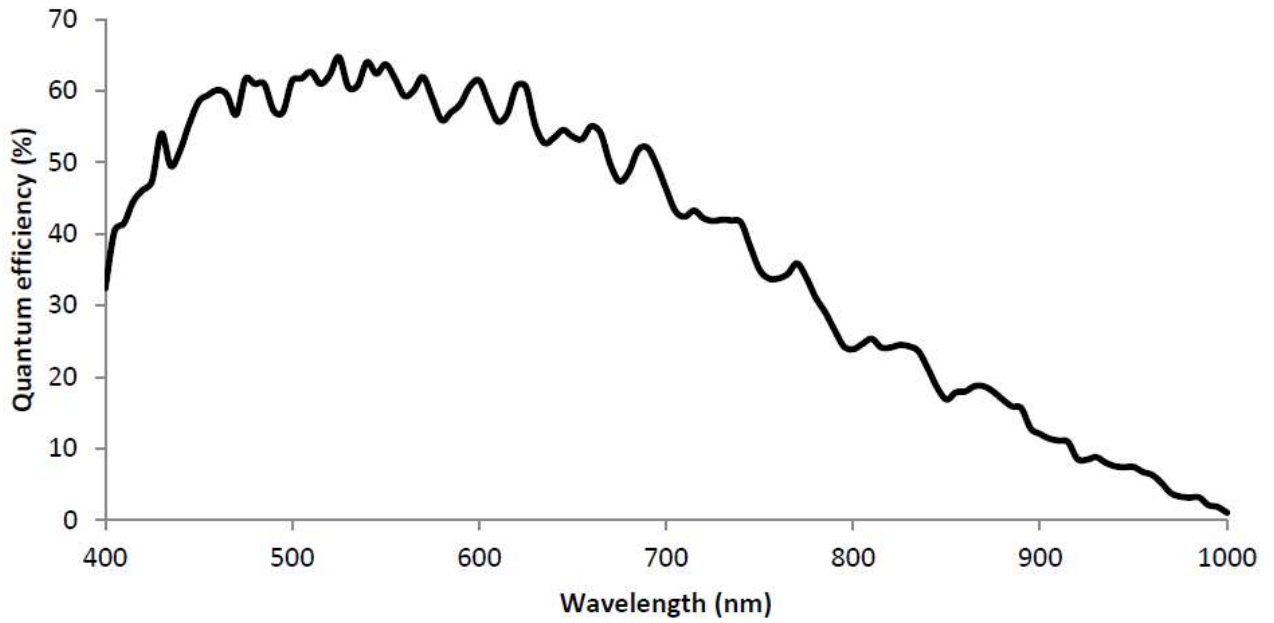

ID4MC-CL (Color)

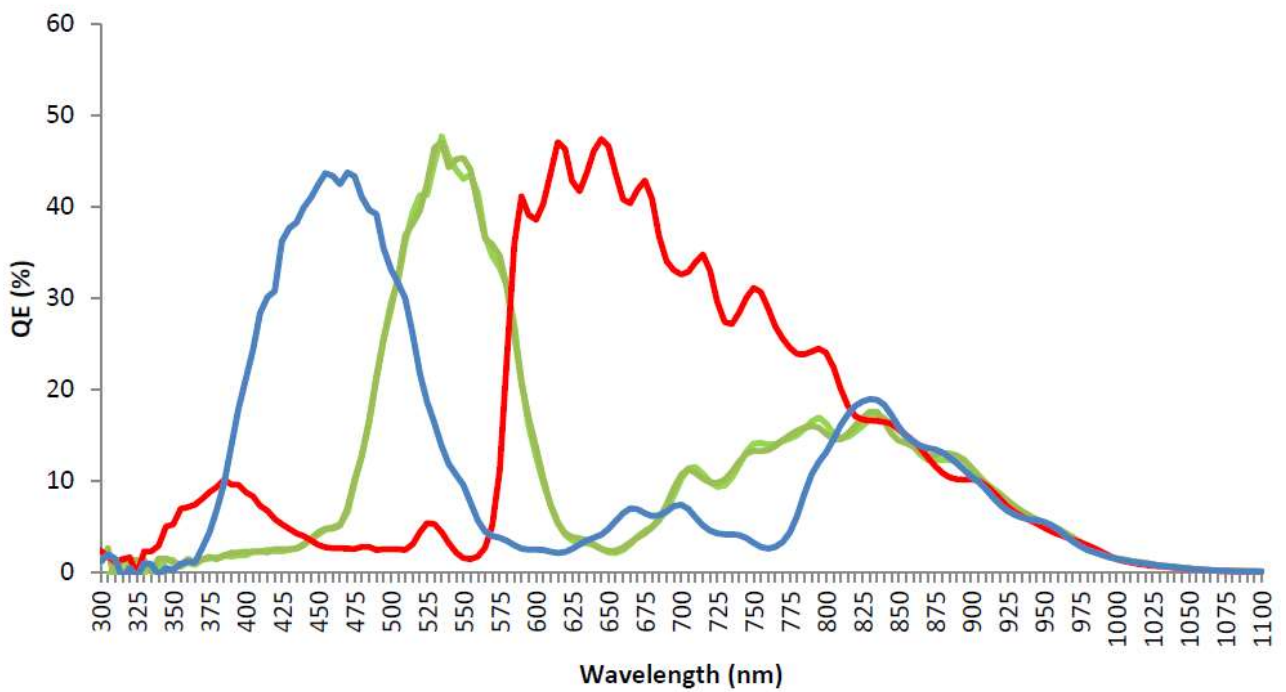

#### 4. Connector

##### 4.1. Camera Link Connector 12226-1100-00PL (SUMITOMO 3M)

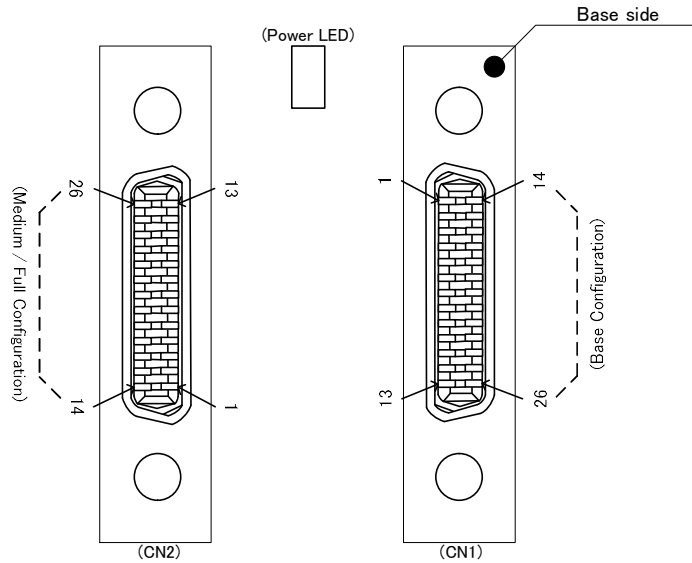

Connector (CN2)

Pin No		Pin No	
1	<b>NC</b>	14	<b>GND</b>
2	Y0-	15	Y0+
3	Y1-	16	Y1+
4	Y2-	17	Y2+
5	Yclk-	18	Yclk+
6	Y3-	19	Y3+
7	100Ω	20	Terminated
8	Z0-	21	Z0+
9	Z1-	22	Z1+
10	Z2-	23	Z2+
11	Zclk-	24	Zclk+
12	Z3-	25	Z3+
13	<b>GND</b>	26	<b>NC</b>

Connector (CN1)

Pin No		Pin No	
1	<b>+12V(PoCL)</b>	14	<b>GND</b>
2	X0-	15	X0+
3	X1-	16	X1+
4	X2-	17	X2+
5	Xclk-	18	Xclk+
6	X3-	19	X3+
7	SerTC+	20	SerTC-
8	SerTFG-	21	SerTFG+
9	CC1- (Trigger IN -)	22	CC1+ (Trigger IN +)
10	CC2+	23	CC2-
11	CC3-	24	CC3+
12	CC4+	25	CC4-
13	<b>GND</b>	26	<b>+12V(PoCL)</b>

##### 4.2. Power LED

Camera turns on LED light, when it is supplied electricity from the frame Grabber board.

\*Power feeding line of CN1 (on Base Configuration connector side) will be connected to the camera internal power input. At this time, power feeding line of CN2 (on Medium/Full Configuration connector side) shall be OPEN. When using at Medium /Full Configuration mode, please contact the frame grabber board manufacturer to make sure that there would be no problem with the above connection.

## 5. Timing Chart

### 5.1. Horizontal Synchronous Signals Timing (2Tap Base Configuration : 38fps)

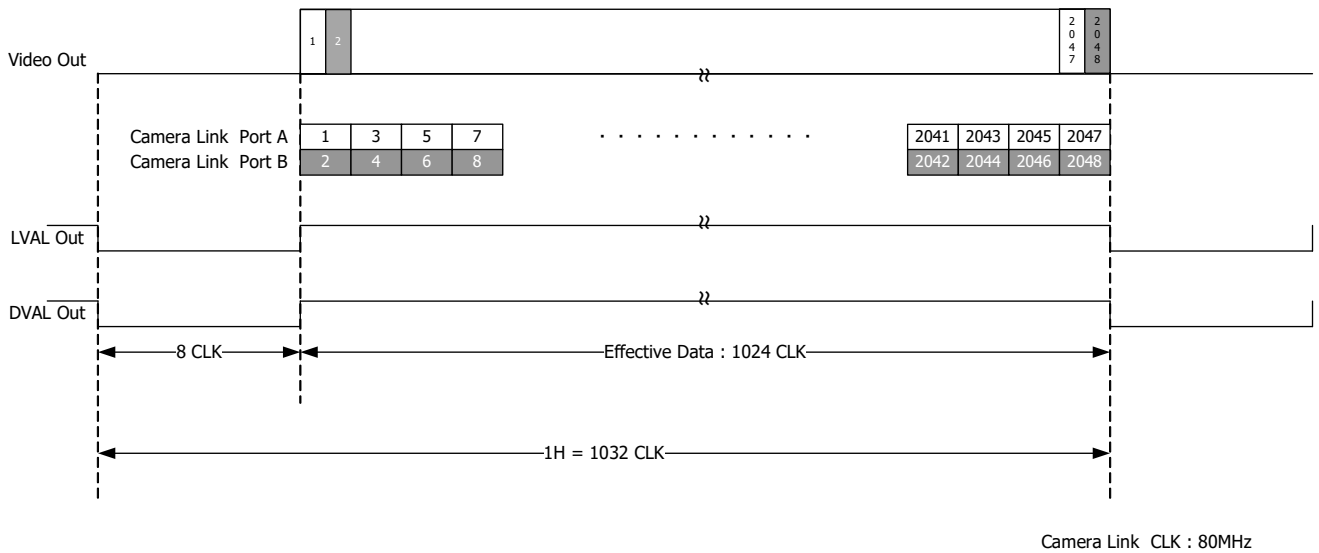

### 5.2. Vertical Synchronous Signals Timing (2Tap Base Configuration : 38fps)

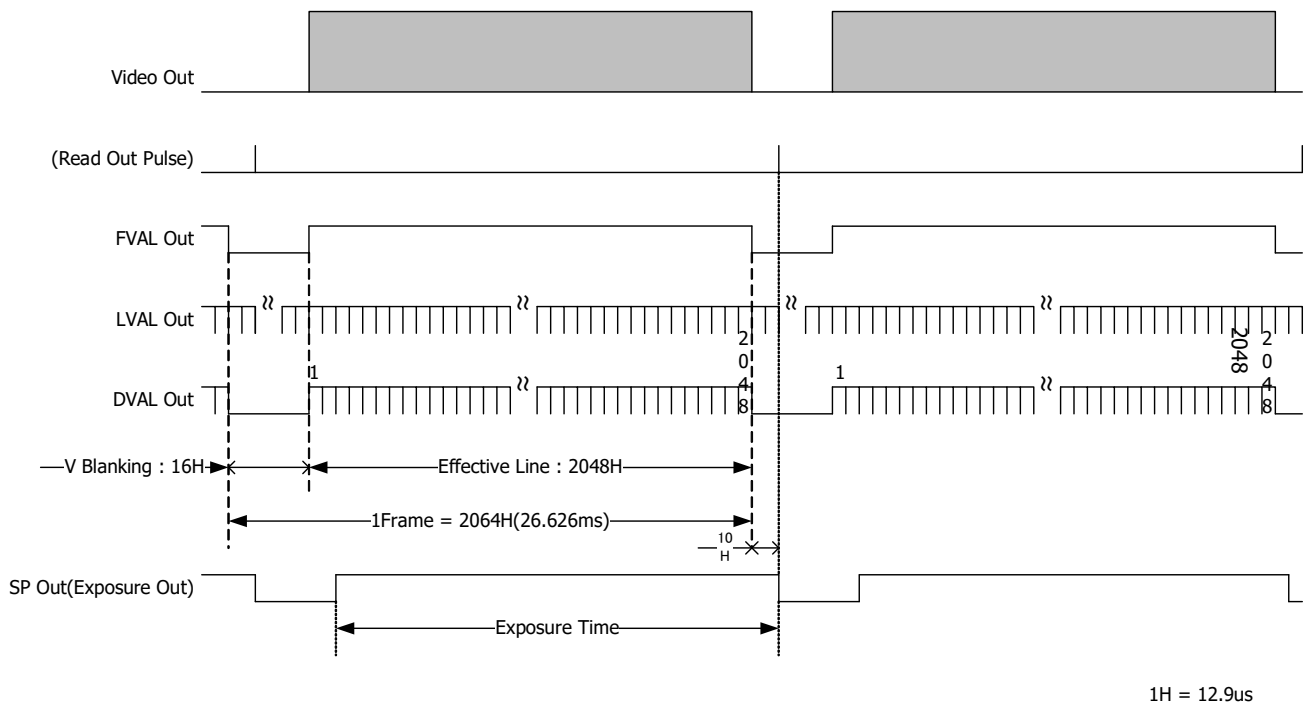



### 5.3. Horizontal Synchronous Signals Timing (4Tap Medium Configuration : 75fps)

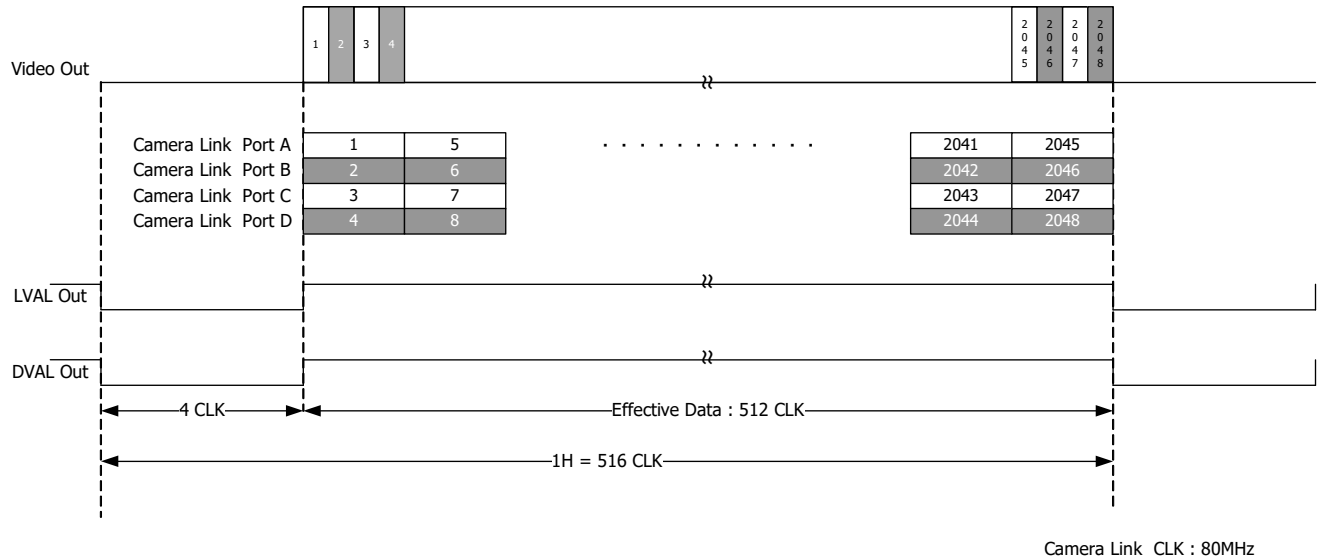

### 5.4. Horizontal Synchronous Signals Timing (2Tap Base Configuration Center Trimming 1024(H))

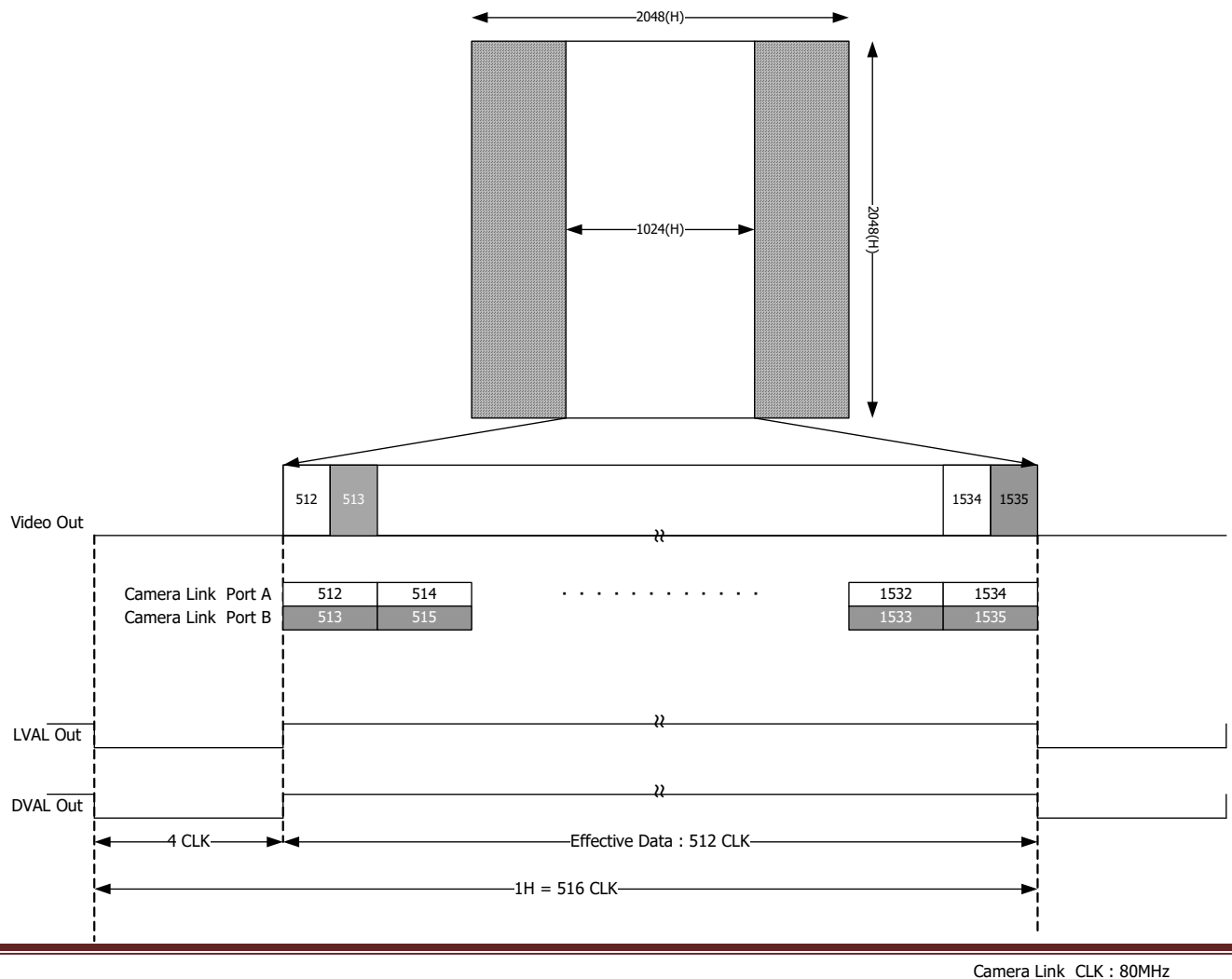

5.5. Vertical Synchronous Signals Timing (4Tap Medium Configuration : 75fps)

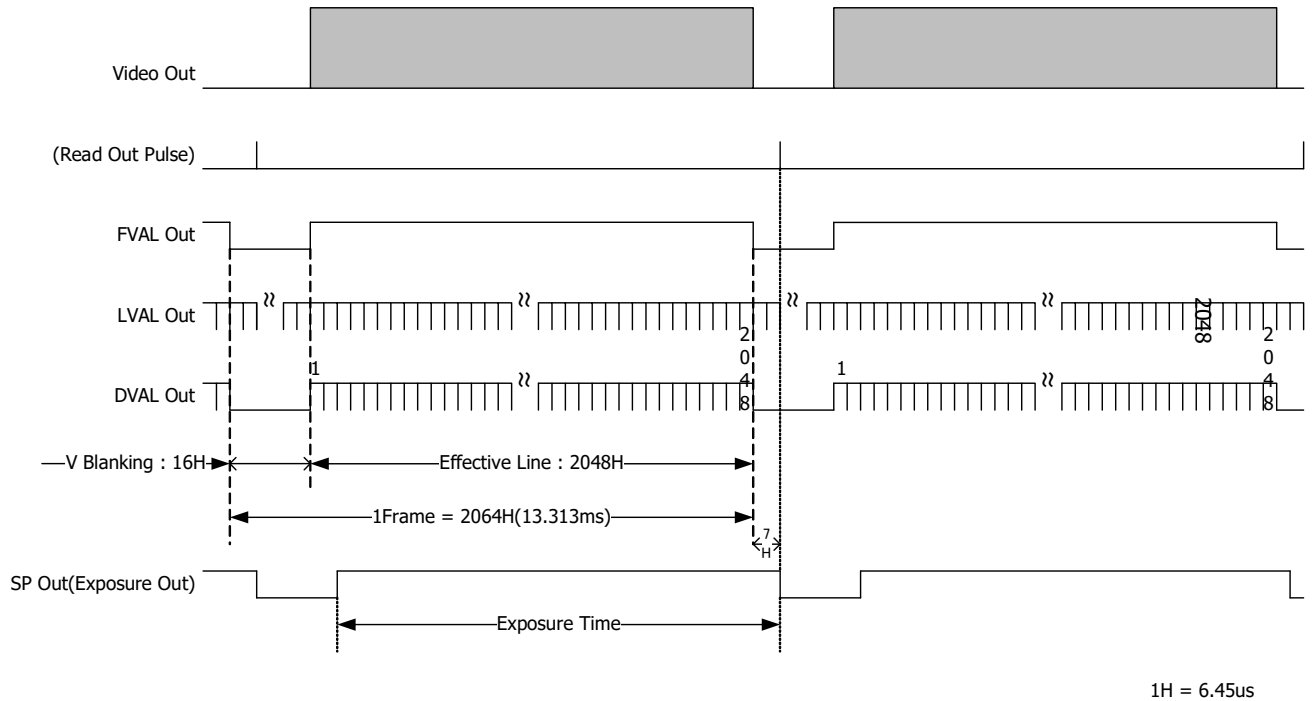

### 5.6. Horizontal Synchronous Signals Timing (8Tap Full Configuration : 150fps)

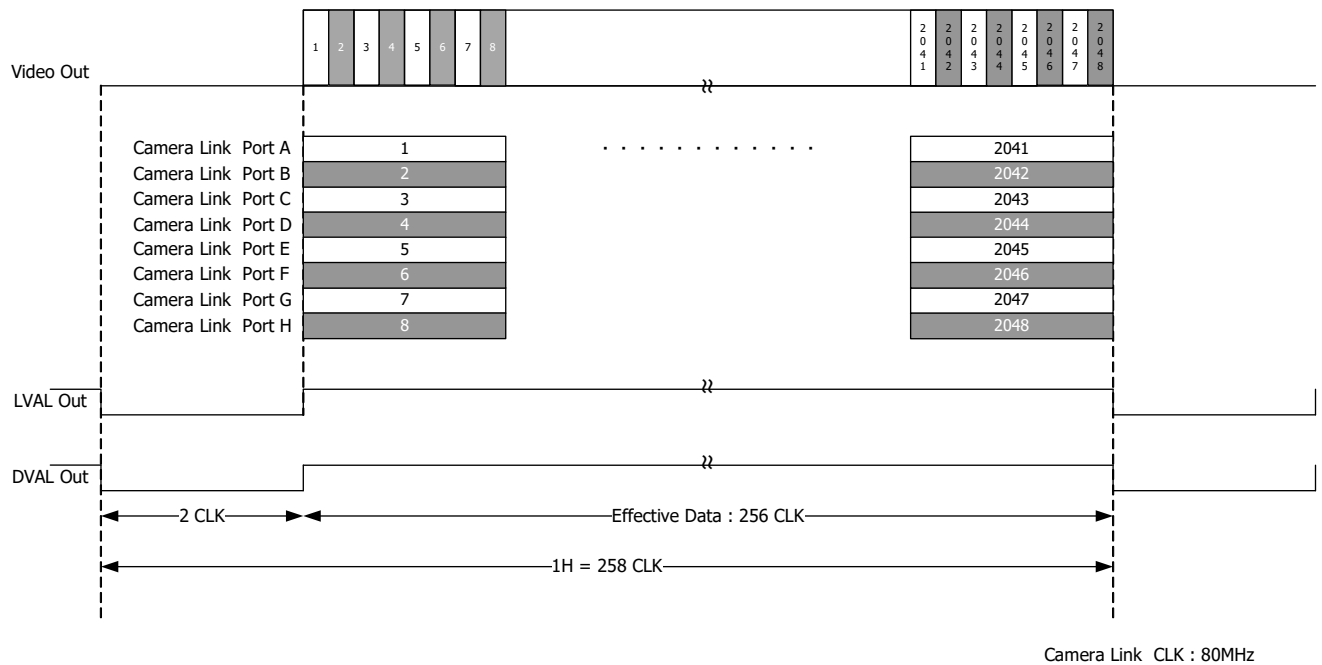

### 5.7. Horizontal Synchronous Signals Timing (2Tap Base Configuration Center Trimming 512(H))

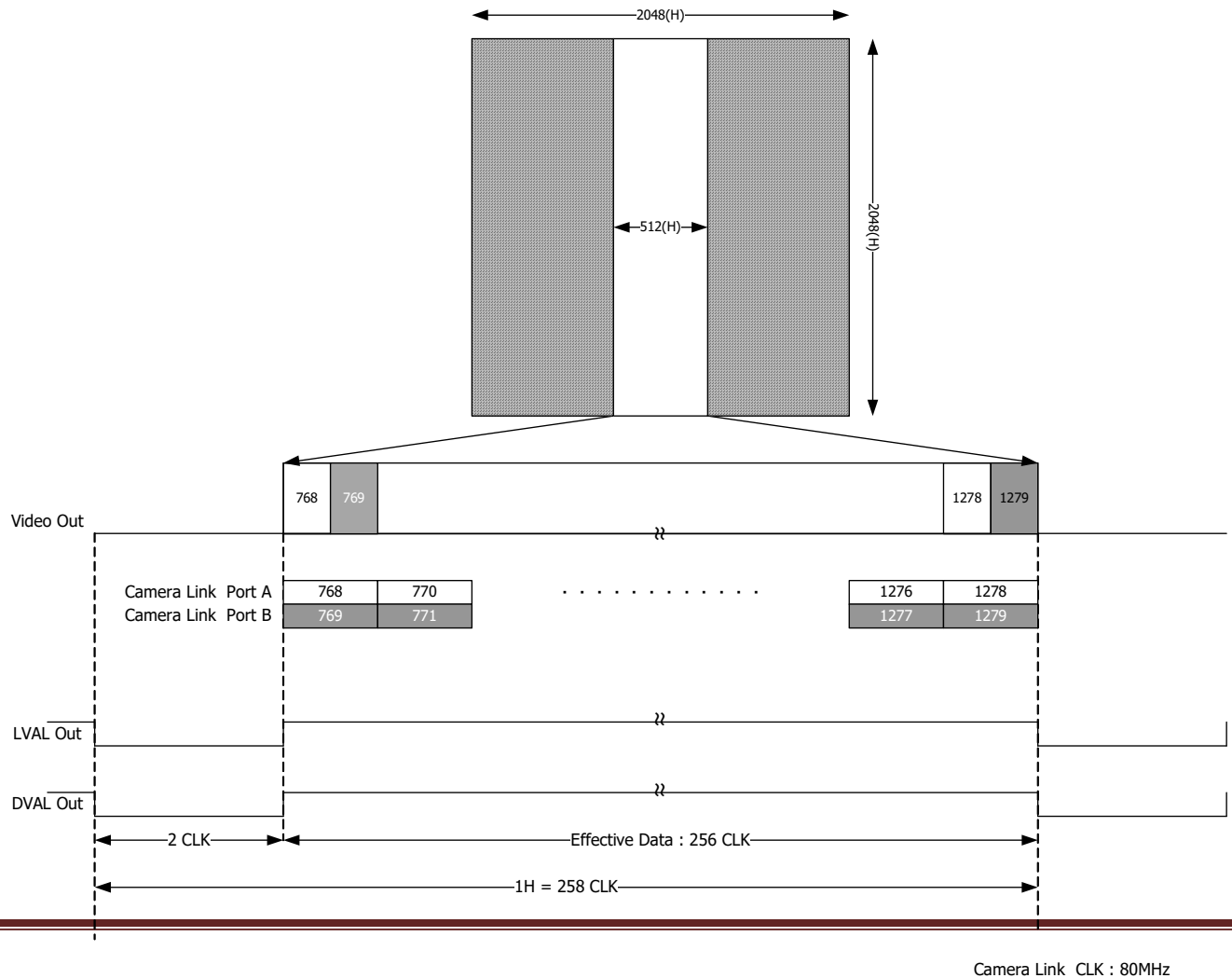

5.8. Vertical Synchronous Signals Timing (8Tap Full Configuration : 150fps)

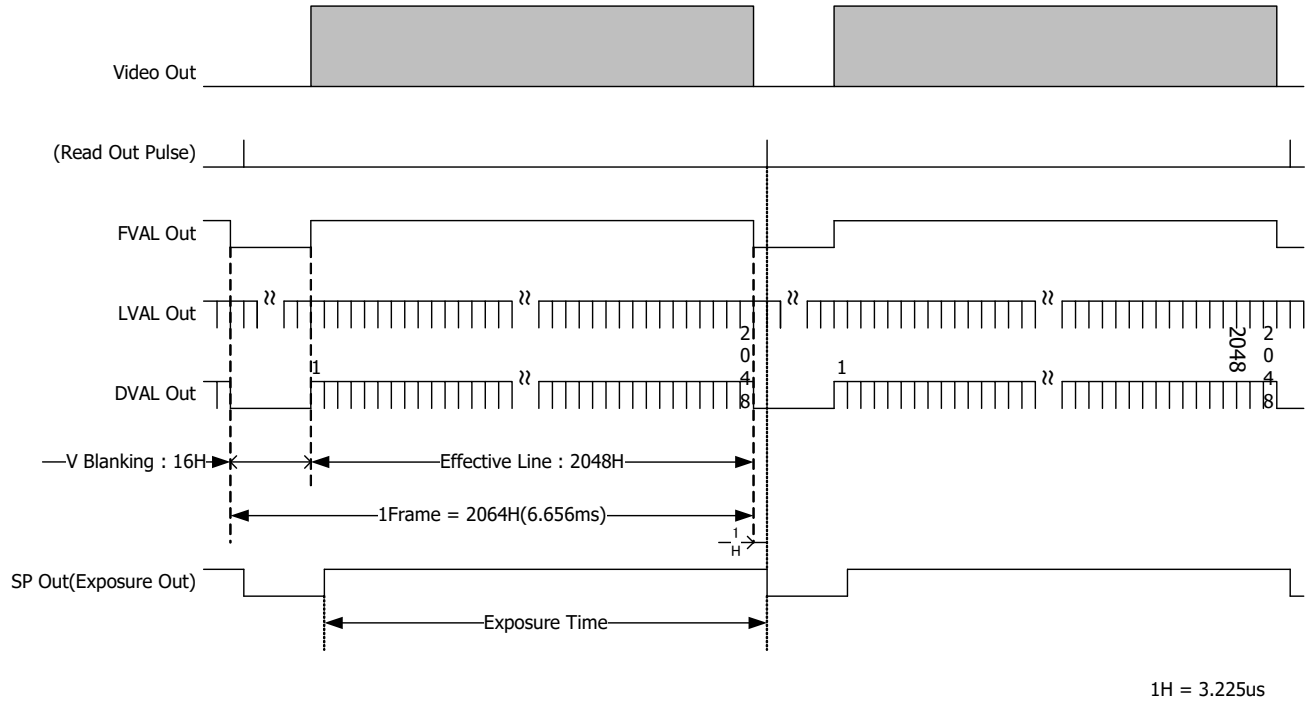

### 5.9. Video Output Format

#### (1) 2Tap Base Configuration : 38fps

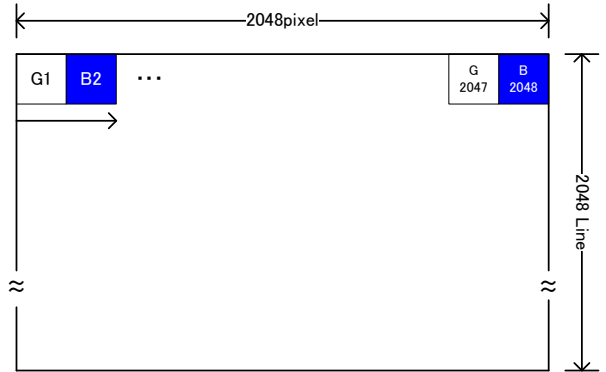
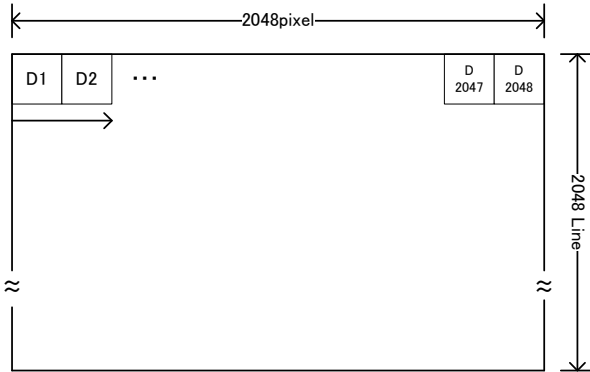

#### (2) 4Tap Base Configuration : 75fps (Initial Setting)

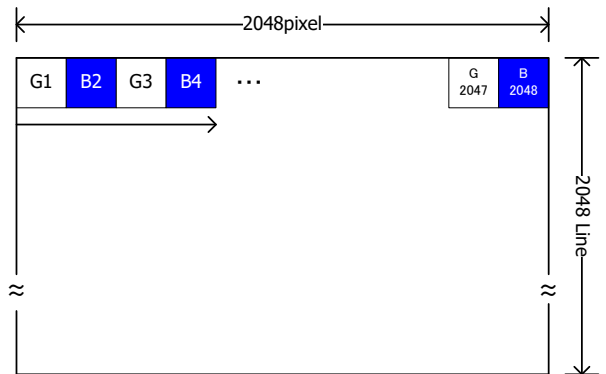
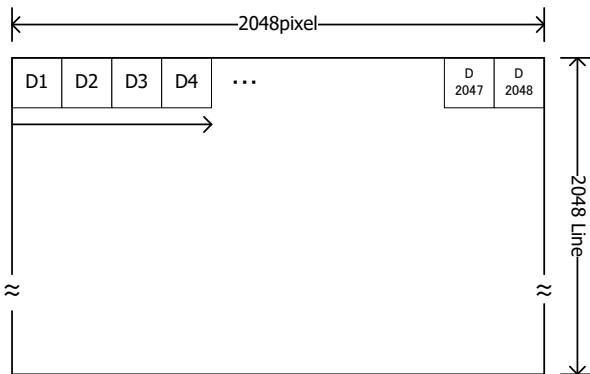

#### (3) 2Tap Base Configuration Center Trimming 1024(H)

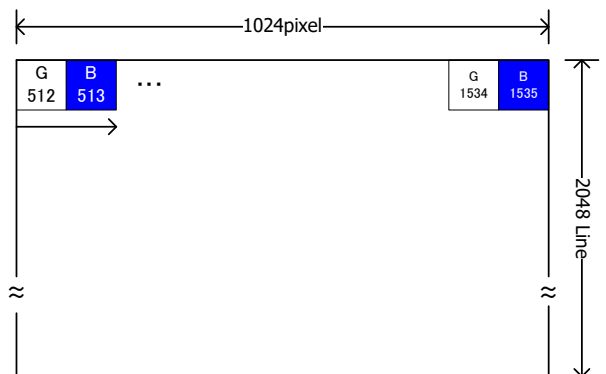
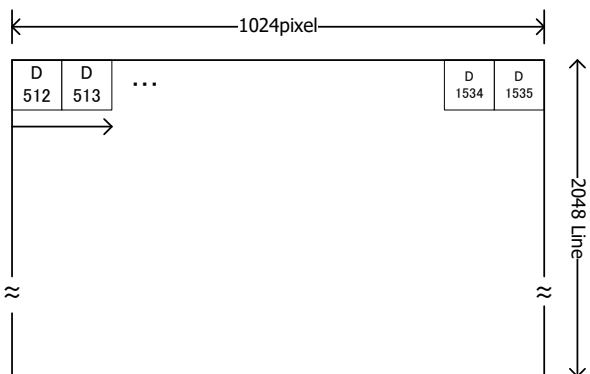

(4) 8Tap Full Configuration : 150fps

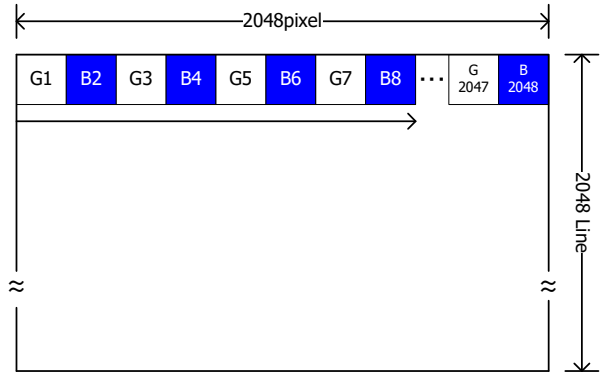
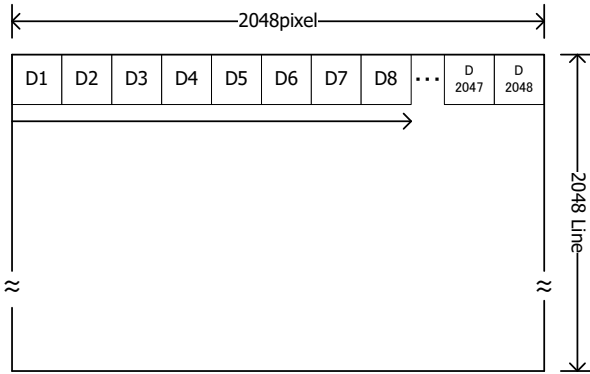

(5) 2Tap Base Configuration Center Trimming 512(H)

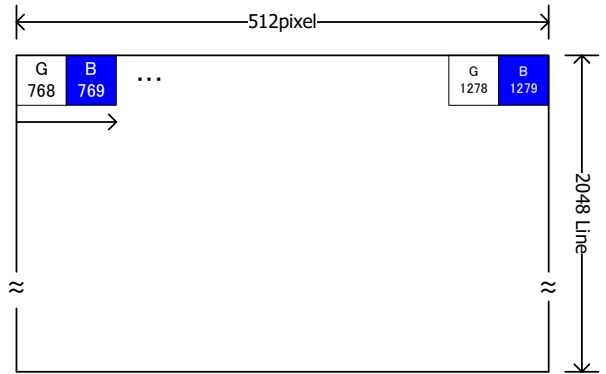
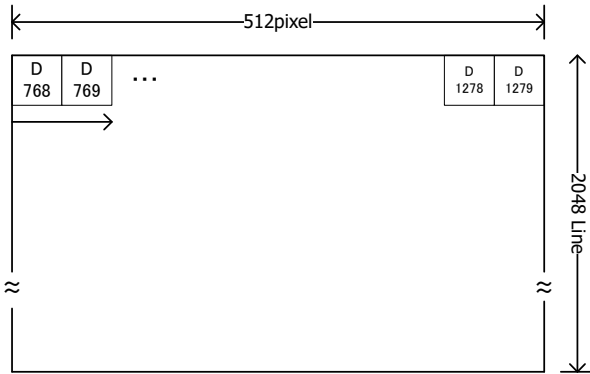

### 5.10. Fixed Trigger Shutter Mode

- This is the mode to start exposure with external input trigger signals, and set the exposure time with serial commands.
- The delay time (Exposure Time Delay) from the detection of the trigger edge inside the camera until the start of exposure is as follows.

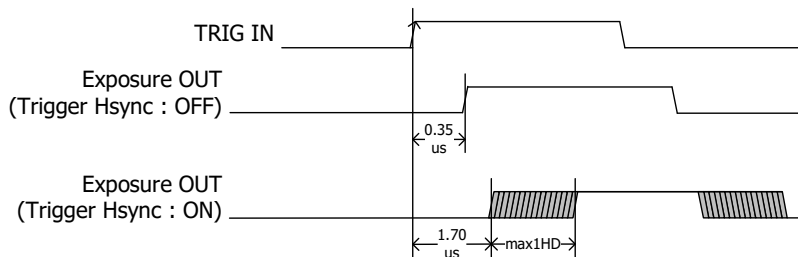

(1) Trigger Hsync Mode ON : 1.70us + max1HD

- 2Tap Base Configuration
  - 4Tap Medium Configuration
  - 8Tap Full Configuration
  - 2Tap Base Configuration Center Trimming 1024(H)
  - 2Tap Base Configuration Center Trimming 512(H)
- 1.70us +
- |   |                   |
|---|-------------------|
| { | max 1HD (12.9us)  |
|   | max 1HD (6.45us)  |
|   | max 1HD (3.225us) |
|   | max 1HD (6.45us)  |
|   | max 1HD (3.225us) |

(2) Trigger Hsync Mode OFF : 0.35us fixed

- Triggers can be accepted even when outputting video signals.  
However, trigger signals for exposure to start the next video output prior to the completion of video transmission for the prior video output signals can not be accepted.
- Trigger input during exposure time should be ignored. (Refer to the below A)

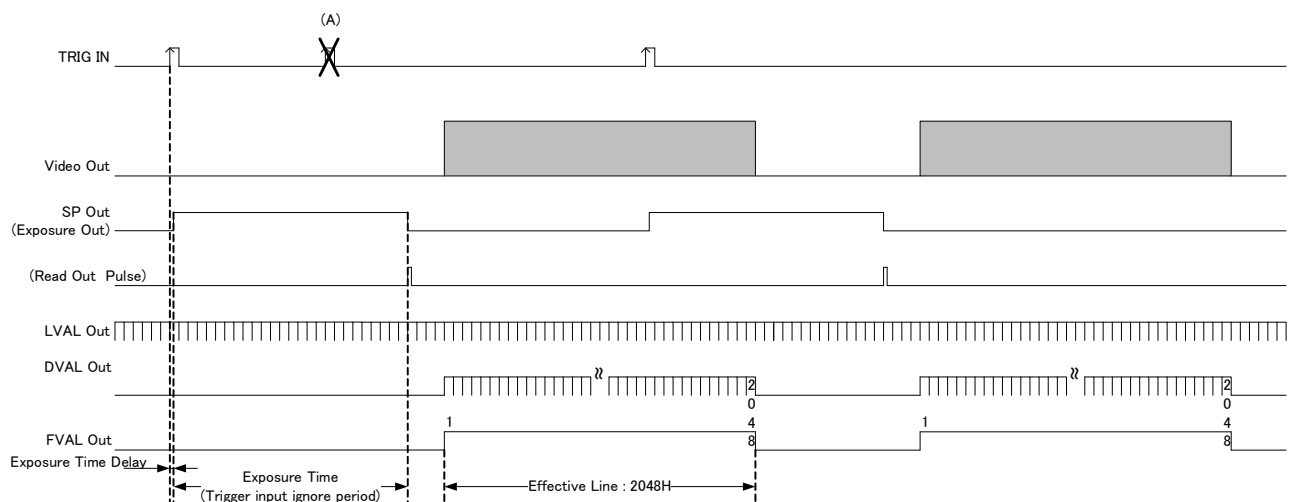

### 5.11. Pulse Width Trigger Shutter Mode

- This is the mode to start exposure with external input trigger signals, and set the exposure time with pulse width of the trigger signals.
- The delay time (Exposure Time Delay) from the detection of the trigger edge inside the camera until the start of exposure is as follows.

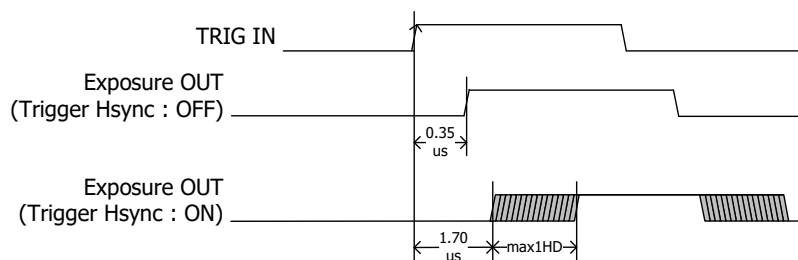

(1) Trigger Hsync Mode ON :  $1.70\mu\text{s} + \text{max1HD}$

- 2Tap Base Configuration
- 4Tap Medium Configuration
- 8Tap Full Configuration
- 2Tap Base Configuration Center Trimming 1024(H)
- 2Tap Base Configuration Center Trimming 512(H)

$$1.70\mu\text{s} + \begin{cases} \text{max 1HD (12.9}\mu\text{s)} \\ \text{max 1HD (6.45}\mu\text{s)} \\ \text{max 1HD (3.225}\mu\text{s)} \\ \text{max 1HD (6.45}\mu\text{s)} \\ \text{max 1HD (3.225}\mu\text{s)} \end{cases}$$

(2) Trigger Hsync Mode OFF :  $0.35\mu\text{s}$  fixed

- Pulse width is min. 2HD (min) to approx. 2 frames.

Functionally, there is no upper limitation, but noises such as dark noises and shadings may be noticeable at long time exposure.

When the pulse width value is under  $16.641\mu\text{s}$ , the exposure time is up to  $16.64\mu\text{s}$ .

- Triggers can be accepted even when outputting video signals.

However, trigger signals for exposure to start the next video output prior to the completion of video transmission for the prior video output signals can not be accepted.

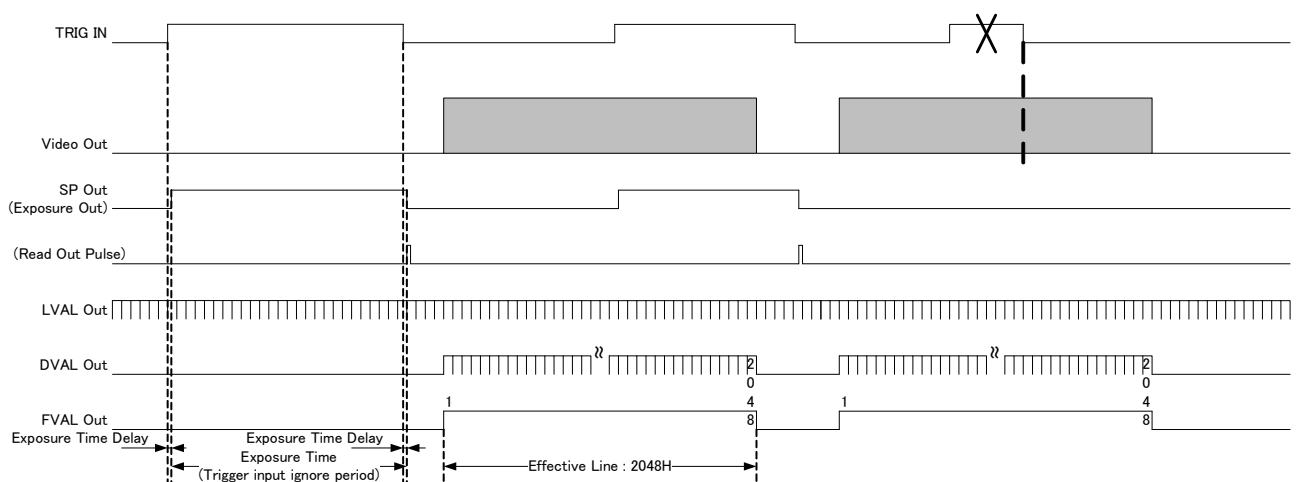



## 6. Center Trimming Mode

- (1) Center Trimming 512(H) Output
- (2) Center Trimming 1024(H) Output

<Example 1.> 512(H) x 512(V) 587fps

Address : 0A	Data : 04	...	Horizontal 512(H) 2Tap Base Configuration Center Trimming
Address : 50-51	Data : 512	...	Vertical 512(V)
Address : 40-41	Data : 768	...	Vertical Start Position 768(V)
Address : 08	Data : 1	...	Partial Scan Mode

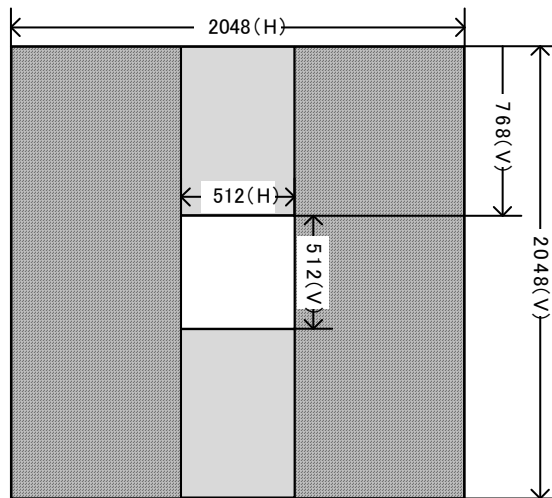

<Example 2.> 1024(H) x 1024(V) 149fps

アドレス:0A	Data : 05	...	Horizontal 1024(H) 2Tap Base Configuration Center Trimming
アドレス:50-51	Data : 1024	...	Vertical 1024(V)
アドレス:40-41	Data : 512	...	Vertical Start Position 512(V)
アドレス:08	Data : 1	...	Partial Scan Mode

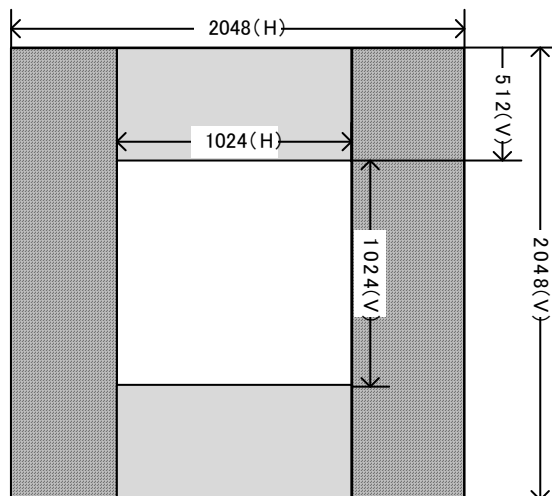

## 7. Partial Scan Mode

□ Maximum 8 partial areas can be set by serial commands.

Example : 3 partial areas to be set.

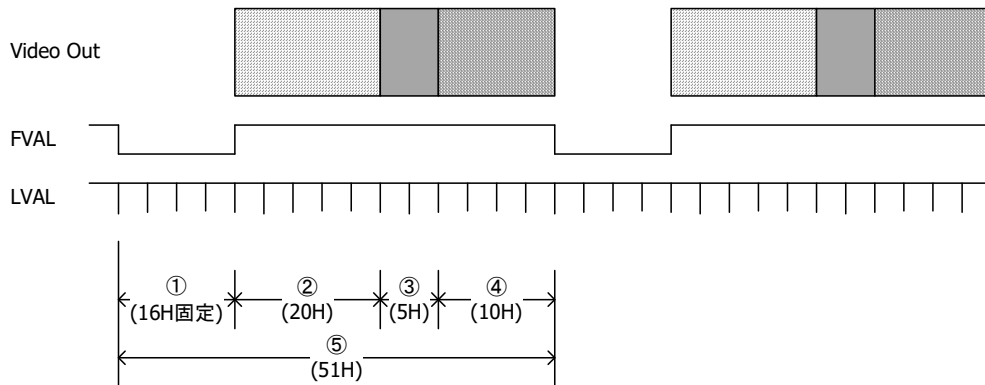
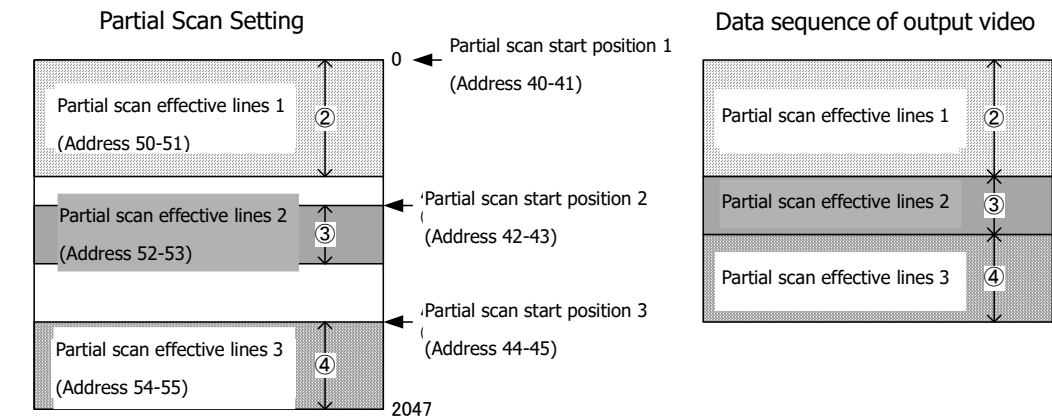

- ① : 16H fixed
- ② : Partial Area 1 : 20H
- ③ : Partial Area 2 : 5H
- ④ : Partial Area 3 : 10H

When setting several partial scan areas, please set the start position and effective lines trying not to overlap the areas.

When setting several areas, please set the areas in the numerical order of start position.

Entire frame line numbers = **V blanking line numbers (16H fixed)** +  
 Partial effective lines 1 + Partial effective lines 2 + ... + Partial effective lines 8

Note that "Sum total of partial effective line numbers (except V blanking lines) < **2048**" should be met.

Frame rate = 1 / (Entire frame line numbers × Time for 1 line)

Camera Mode	Time for 1 Line
2Tap Base Configuration	12.9us
4Tap Medium Configuration 2Tap Base Configuration Center Trimming 1024(H)	6.45us
8Tap Full Configuration 2Tap Base Configuration Center Trimming 512(H)	3.225us

Example

	Effective Line Number	Frame Total Line Number	Frame Rate (Total Line)		
			2Tap Base Configuration	4Tap Medium Configuration	8Tap Full Configuration
1(B/W:Min)	1 H	17H	4560fps	9120fps	18240fps
1(Color:Min)	2 H	18H	4307fps	8613fps	17227fps
Vertical:VGA	480 H	496H	156fps	313fps	625fps
.	.				
Vertical:XGA	768 H	784H	99fps	198fps	396fps
.	.				
Vertical:SXGA	1024 H	1040H	75fps	149fps	298fps
.	.				
Vertical:UXGA	1200 H	1216H	64fps	127fps	255fps
.	.				
2048 (Max)	2048 H	2064H	38fps	75fps	150fps

## 8. Remote Communication

Via camera link cable, the camera can be controlled.

Communication Settings	
Baud Rate	: 9600bps (Initial Setting)
Data	: 8bit
Stop bit	: 1bit
Parity	: None
XON / XOFF	: No Control

- Send Command Format (Host to Camera)

If send a command, set the command and parameter between STX and ETX.

STX (02H)	command (2byte)	parameter (ASCII code) (20H-7FH)	ETX (03H)
--------------	--------------------	-------------------------------------	--------------

- Return Command Format (Camera to Host)

Normally, a camera returns a control code which is ACK or NAK.

If return value has a text message, the message is between STX and ETX.

ACK (06H)	...	Succeed
--------------	-----	---------

NAK (15H)	...	Fail
--------------	-----	------

STX (02H)	command (2byte)	parameter (ASCII code) (2FH- 7FH)	ETX (03H)	...	return message
--------------	--------------------	--------------------------------------	--------------	-----	----------------

- Command List

Command	Function
SR	Set some values of resister
GR	Get some values of resister
SU	Set a user's data
GU	Get a user's data
CS	Save all configurations
CR	Restore all configurations
QM	Get a model name
QS	Get a serial number
QV	Get a firmware version
QE	Get a detail of error information

### 8.1. Command Specifications

1) Set some values of resister

**【Command】** Set : Resister

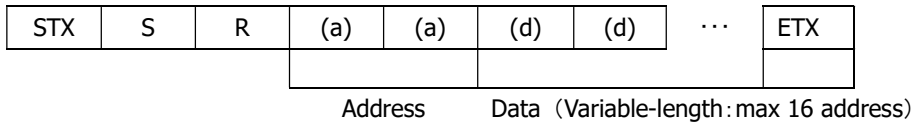

**【Return Value】**

Succeed	...	ACK
Fail	...	NAK

2) Get some value of resister

**【Command】** Get : Resister

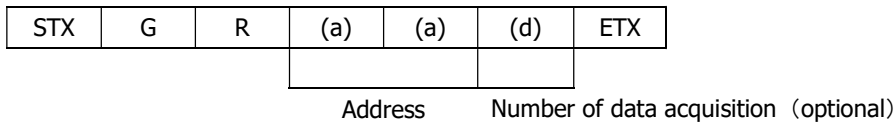

**【Return value】**

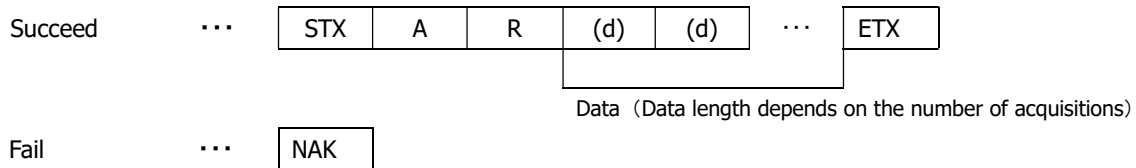

**【Remarks】**

The command gets some value of register of the specified address. The number of the acquisition is between '0' and 'F'( Hexadecimal ).

If appoint '0' at the address, the command send data of 16 address. If the command is omitted at the address, the command send an address.

### 3) Set User's data

【Command】 Set : User's data

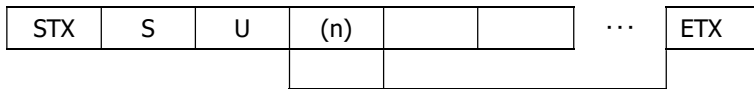

Table No.            User's data (fixed length :16byte)  
(0~3)

【Return Value】

Succeed	...	ACK
Fail	...	NAK

【Remarks】

The commands, sets free data on the specified register, and can use 4 tables (1 table : 16 characters).

### 4) Get User's data

【Command】 Get : User's data

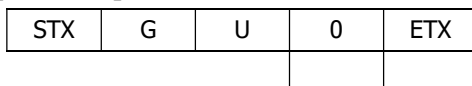
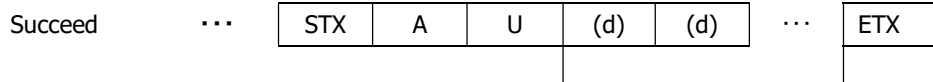

Table No.  
(0~3)

【Response】



User's data (fixed length : 16byte)

Fail	...	NAK
------	-----	-----

5) Save all configurations

【Command】 Configuration : Save

STX	C	S	ETX
-----	---	---	-----

【Return Value】

Succeed	...	ACK
Fail	...	NAK

6) Restore all configurations

【Command】 Configuration : Restore

STX	C	R	ETX
-----	---	---	-----

【Return Value】

Succeed	...	ACK
Fail	...	NAK

7) Get a model name

【Command】 Query : Model name

STX	Q	M	ETX
-----	---	---	-----

【Return Value】

Succeed	...	STX	R	M	(d)	(d)	...	ETX
					Model name (Fixed length: 16byte)			
Fail	...	NAK						

8) Get a serial number

【Command】 Query : Serial number

STX	Q	S	ETX
-----	---	---	-----

【Return Value】

Succeed	...	STX	R	S	(d)	(d)	...	ETX
					Serial Number(Fixed length: 8byte)			
Fail	...	NAK						

---

---

9) Get a firmware version

【Command】 Query : Version

STX	Q	V	ETX
-----	---	---	-----

【Return Value】

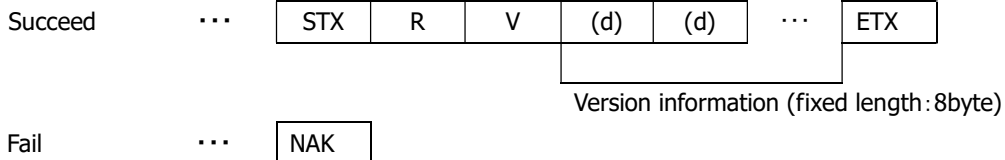

10) Get a detail of error information

【Command】 Query : Error

STX	Q	E	ETX
-----	---	---	-----

【Return Value】

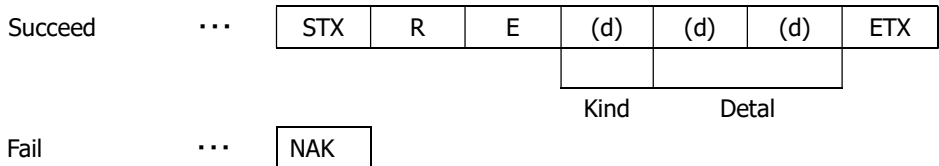

Kind	Detail
0: No Error	00: Normal result
1: Communication Protocol Error	00: The command is undefined.
	01: The command length is more than defined.
	02: The address is undefined.
	03: The value of data is undefined.
	04: The length is more than defined.
	05: The table number is undefined.
	06: The string of user data was abnormal.
2: Internal Control Error	00: Internal control is abnormal.
	01: A read only address was written by the command.
	02: A protected address was written by the command.
	03: Out of range address was written by the command.
	04: The selected table number is abnormal.
	05: The value of the man acquisition area is abnormal.
	06: A function is not implemented.



## 8.2. Control Example

1) How to check trigger shutter mode. ( The command gets a value from address 04)

【Send Command】

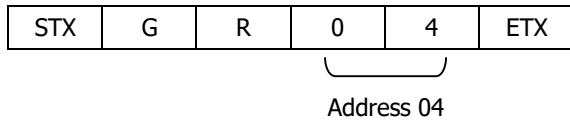

【Return value form camera】

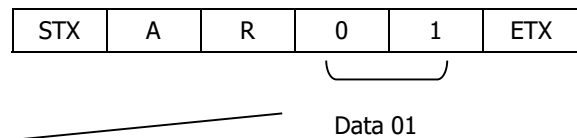

【Receive Return Value】

The camera is working with a trigger shutter mode, because the command received a 01 from the camera.

2) How to check trigger shutter mode. ( The command gets consecutive 2 bytes values from address 20)

【Send Command】

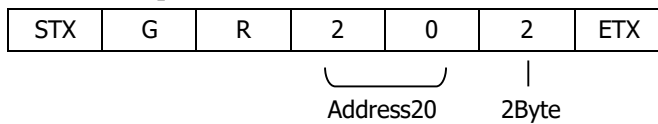

【Receive return value】

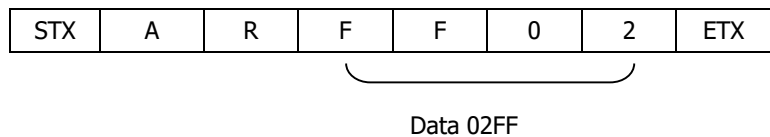

【Receive return value】

The shutter mode of camera is working +12dB, because the command received a 02FF(767) from the camera.

3) How to set partial scan mode. (The command sets 01 for address 08)

【Send Command】

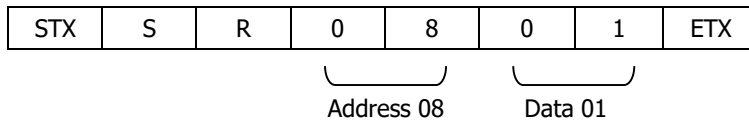

【Return value form camera】

ACK

【Receive Return Value】

The command finished normally, because the command received ACK from the camera.

4) How to set 01FF for manual shutter. (The command set 01FF for address 24)

【Send Command】



【Return value form camera】

ACK

【Receive Return Value】

The command finished normally, because the command received ACK from the camera.

---

---

5) How to save configurations of a camera. (The command send CS)

【Send Command】

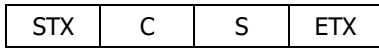

【Return value form camera】



【Receive Return Value】

The command finished normally, because the command received ACK from the camera.

6) How to restore the camera to initial settings. (The command send CR)

【Send Command】



【Return value form camera】



【Receive Return Value】

The command finished normally, because the command received ACK from the camera.

---

---

7) How to get detail of a communication error.

【Send Command】

STX	G	R	@	0	ETX
-----	---	---	---	---	-----

Set the address invalid value



【Return value form camera】

NAK
-----



【Receive return value】

The command finished abnormally, because the command received 'NAK' from the camera.

When the command did not finish normally, retry to send command or send to get detail of a detail error command.

【Send Command】

STX	Q	E	ETX
-----	---	---	-----

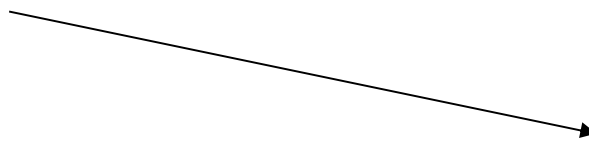

【Return value form camera】

STX	R	E	1	0	2	ETX
-----	---	---	---	---	---	-----

Kind1      Detail 02



【Receive Return Value】

The 'GR' command accessed invalid address , because the error command received kind '1' and detail '02'.

---

---

## 9. Function Setting

Function	Address(Hex)	Data(Hex)			
Shutter	01		2Tap Base Configuration	4Tap Medium Configuration	8Tap Full Configuration
		00:	1/38s(OFF)	1/75s(OFF)	1/150s(OFF)
		01:	1/75s	1/75s(OFF)	1/150s(OFF)
		02:	1/150s	1/150s	1/150s(OFF)
		03:	1/350s	1/350s	1/350s
		04:	1/500s	1/500s	1/500s
		05:	1/1000s	1/1000s	1/1000s
		06:	1/2500s	1/2500s	1/2500s
		07:	1/5000s	1/5000s	1/5000s
		08:	1/7500s	1/7500s	1/7500s
		09:	1/10000s	1/10000s	1/10000s
		0A:	1/15000s	1/15000s	1/15000s
		0B:	1/20000s	1/20000s	1/20000s
		0C:	1/30000s	1/30000s	1/30000s
		0D:	1/30000s	1/40000s	1/40000s
		0E:	1/30000s	1/40000s	1/50000s
			0F:	Manual (Refer to Address 24-25)	
White Balance (Color model)	02	00:	THRU		
		01:	3200K		
		02:	THRU(Spare)		
		03:	Manual		
Trigger Mode	04	00:	Normal (Trigger OFF)		
		01:	Fixed Trigger Shutter Mode		
		02:	Pulse Width Trigger Shutter Mode		
Trigger Polarity	05	00:	Positive		
		01:	Negative		
Partial Scan Mode	08	00:	Full Frame		
		01:	Partial Scan		
Output Mode	0A	00:	8Tap Full Configuration (150fps)		
		01:	4Tap Medium Configuration (75fps)		
		02:	2Tap Base Configuration (38fps)		
		03:	-		
		04:	2Tap Base Configuration Center Trimming 512(H)		
		05:	2Tap Base Configuration Center Trimming 1024(H)		
		06:	-		
		07:	-		
Output Data Selection	0B	00:	8bit		
		01:	10bit (8Tap Full Configuration : 8bit only)		

Function	Address(Hex)	Data(Hex)	
Baud Rate	10	00:	9600bps
		01:	19200bps
		02:	38400bps
		03:	57600bps
		04:	115200bps
Trigger Hsync Mode	17	00:	OFF
		01:	ON
Output Image Flip Vertical	18	00:	Normal
		01:	Flip Vertical
LED ON/OFF	1B	00:	OFF
		01:	ON
Manual Gain	20-21	LLHH:	min:0(0H) - max:767(2FFH) 0: x1(0dB), 767: x4(+12dB)
Manual Shutter	24-25	LLHH:	min:0(0H) - max:2047(7FFH)
			2Tap Base Configuration: Shutter time = 16.641us + (2048 - (setting value))×12.9us min:0=26.436ms(1/38s), max:2047=29.541us(1/30000s)
			4Tap Medium Configuration / 2Tap Base Configuration Center Trimming 1024(H): Shutter time = 16.641us + (1088 - (setting value))×6.45us min:0=13.226ms(1/75s), max:2047=23.091us(1/40000s)
			8Tap Full Configuration / 2Tap Base Configuration Center Trimming 512(H): Shutter time = 16.641us + (2048 - (setting value))×3.225us min:0=6.621ms(1/150s), max:2047=19.866us (1/50000s)
Manual White Balance R (Color model)	28-29	LLHH:	min:0(0H) - max:767(2FFH) 0: x1(0dB), 767: x4(+12dB)
Manual White Balance B (Color model)	2A-2B	LLHH:	min:0(0H) - max:767(2FFH) 0: x1(0dB), 767: x4(+12dB)
Manual White Balance G (Color model)	2C-2D	LLHH:	min:0(0H) - max:767(2FFH) 0: x1(0dB), 767: x4(+12dB)

※ LLHH : The data set with 2 Byte shall be set with Low Byte first, then set with High Byte.

< Example > Manual Shutter (Address 24-25) ->6671(1A0FH)

STX SR 24 0F 1A ETX

Function	Address(Hex)	Data(Hex)	
Cursor Position X Coordinate	3C-3D	LLHH:	min:0(0H) - max:2047(7FFH)
Cursor Position Y Coordinate	3E-3F	LLHH:	min:0(0H) - max:2047(7FFH)
Partial Scan Start Position 1	40-41	LLHH:	min:0(0H) - max:2047(7FFH) *ID4MC-CL : Color Camera Start Position Setting -> Only even number *If you not use partial scan function, you need to set "start position 1~8=0".
Start Position 2	42-43		
Start Position 3	44-45		
Start Position 4	46-47		
Start Position 5	48-49		
Start Position 6	4A-4B		
Start Position 7	4C-4D		
Start Position 8	4E-4F		
Partial Scan Effective Line 1	50-51	LLHH:	min:1(1H) - max:2048(800H) *ID4MC-CL : Color Camera Effective Line Setting -> Only even number *If you not use partial scan function, you need to set "effective line 1=1088(440H),2~8=0(0H)".
Effective Line 2	52-53		
Effective Line 3	54-55		
Effective Line 4	56-57		
Effective Line 5	58-59		
Effective Line 6	5A-5B		
Effective Line 7	5C-5D		
Effective Line 8	5E-5F		

※ LLHH : The data set with 2 Byte shall be set with Low Byte first, then set with High Byte.

< Example > Manual Shutter(Address 24-25) ->6671(1A0FH)

STX SR 24 0F 1A ETX

10. CMOS Optical Axis Accuracy

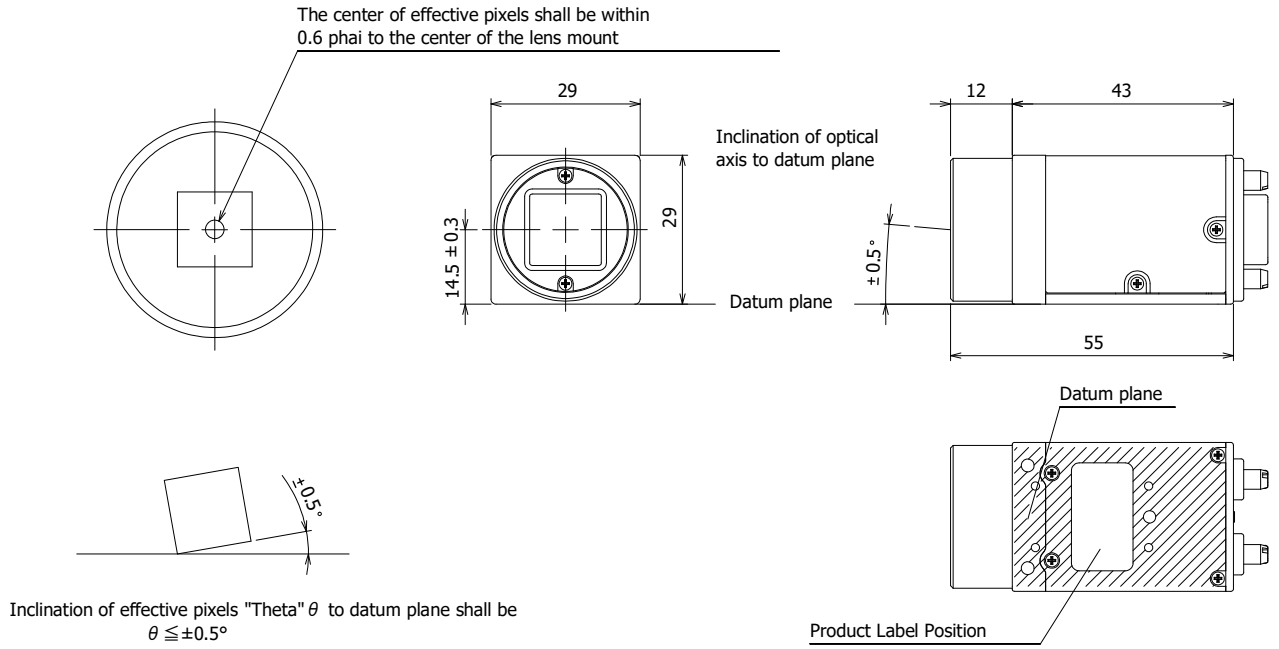



**11. Dimensions**

- \*1) Screw length from the lens mount surface shall be under 6mm.  
And protruding portion shall be less than 10mm.
- \*2) C mount screws comply with ANSI/ASME B1.1,1-32UN(2B).

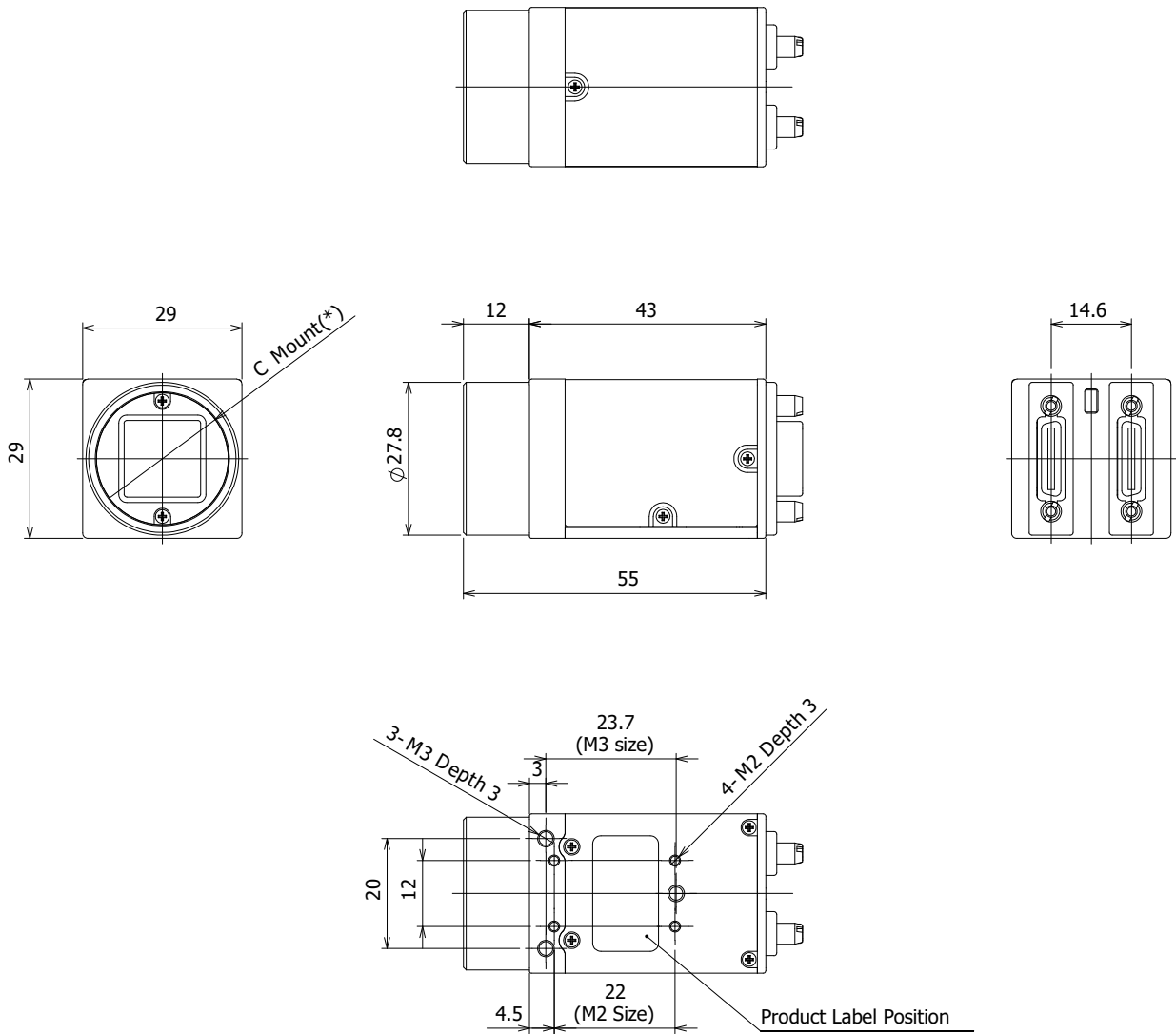

**12. Initial Setting**

Function	Address	Data	
Shutter	01	00:	1/75s(OFF)
White Balance (Color model)	02	01:	3200K
Trigger Mode	04	00:	Normal (Trigger OFF)
Trigger Polarity	05	00:	Positive
Partial Scan Mode	08	00:	Full Frame
Camera Mode	0A	01:	4Tap Medium Configuration
Output Data Selection	0B	00:	8bit
Baud Rate	10	00:	9600bps
Trigger Hsync Mode	17	01:	ON
Output Image Flip Vertical	18	00:	Normal
LED ON/OFF	1B	01:	ON
Manual Gain	20-21	0000:	0dB
Manual Shutter	24-23	0000:	Shutter (OFF)
Manual White Balance R (Color model)	28-29	0000:	0dB
Manual White Balance B (Color model)	2A-2B	0000:	0dB
Manual White Balance G (Color model)	2C-2D	0000:	0dB
Partial Scan Start Position	40-41,42-43, 44-45,46-47, 48-49,4A-4B, 4C-4D,4E-4F	0000:	Start Position 0
Partial Scan Effective Lines	50-51	0008:	Effective Lines 2048
	52-53,54-55, 56-57,58-59, 5A-5B,5C-5D, 5E-5F	0000:	Effective Lines 0

### 13. Cases for Indemnity (Limited Warranty)

We shall be exempted from taking responsibility and held harmless for damage or losses incurred by the user in the following cases.

- In case damage or losses are caused by fire, earthquake, or other acts of God, acts by third party, deliberate or accidental misuse by the user, or use under extreme operating conditions.
- In case indirect, additional, consequential damages (loss of business interests, suspension of business activities) are incurred as result of malfunction or non-function of the equipment, we shall be exempted from responsibility for such damages.
- In case damage or losses are caused by failure to observe the information contained in the instructions in this product specification & operation manual.
- In case damage or losses are caused by use contrary to the instructions in this product specification & operation manual.
- In case damage or losses are caused by malfunction or other problems resulting from use of equipment or software that is not specified.
- In case damage or losses are caused by repair or modification conducted by the customer or any unauthorized third party (such as an unauthorized service representative).

### 14. CMOS Pixel Defect

IDULE compensates the noticeable CMOS pixel defects found at the shipping inspection prior to our shipment. On very rare occasions, however, CMOS pixel defects might be noted with time of usage of the products.

Cause of the CMOS pixel defects is the characteristic phenomenon of CMOS itself and IDULE is exempted from taking any responsibilities for them. Should you have any questions on CMOS pixel defects compensation, please contact us.

### 15. Product Support

When defects or malfunction of our products occur, and if you would like us to investigate on the cause and repair, please contact your distributors you purchased from to consult and coordinate.

---

---