

---

---

**1.2Mega CMOS USB Camera**

**ID1MB-MDL(L)-U (B/W)**

**ID1MC-MDL(L)-U (COLOR)**

**Technical Manual**

**iDule Corporation**

---

---

## Table of Contents

	PAGE
1. <b>Product Outline</b> .....	3
2. <b>Handling Precautions</b> .....	3
3. <b>Specification</b> .....	4
3.1. General Specification .....	4
3.2. Camera Output Signal Specification .....	5
3.3. Spectral Response (Representative Value) .....	6
4. <b>Connector</b> .....	7
4.1. Connector P1 .....	7
4.2. Connector CN1 .....	7
5. <b>Timing Chart</b> .....	8
5.1. USB3.0 Normal Shutter Mode .....	8
5.2. USB3.0 Fixed Trigger Shutter Mode .....	8
5.3. USB2.0 Normal Shutter Mode .....	9
5.4. USB2.0 Fixed Trigger Shutter Mode .....	9
5.5. Output Format .....	10
5.6. Fixed Trigger Shutter Mode .....	11
6. <b>Scan Mode</b> .....	12
6.1. Partial Scan Mode .....	12
7. <b>Binning Mode</b> .....	14
8. <b>VGA Mode</b> .....	14
9. <b>QVGA Mode</b> .....	15
10. <b>UVC Extension Units (USB) Function</b> .....	16
11. <b>Function Setting</b> .....	16
12. <b>Dimensions</b> .....	19
13. <b>Initial Setting</b> .....	20
14. <b>Cases for Indemnity (Limited Warranty)</b> .....	21
15. <b>CMOS Pixel Defect</b> .....	21
16. <b>Product Support</b> .....	21

---

---

## 1. Product Outline

ID1MB-MDL-U /ID1MC-MDL-U is a USB3.0/2.0 interfaced and 1.2Mega resolution camera module. 1.2Mega pixels CMOS sensor with diagonal length 6.0mm is utilized. Entire pixels can be read out within 1/54s.

### Features

- Global Shutter CMOS sensor is utilized.
- Fixed trigger shutter mode is operable.
- USB3.0 / 2.0 output
- USB UVC (YUV-RAW) / Y8(RAW)
- USB BUS POWER

## 2. Handling Precautions

The camera must not be used for any nuclear equipment or aerospace equipment with which mechanical failure or malfunction could result in serious bodily injury or loss of human life. Our warranty does not apply to damages or defects caused by irregular and /or abnormal use of the product.

Please observe all warnings and cautions stated below.

Our warranty does not apply to damages or malfunctions caused by neglecting these precautions.

Do not use or store the camera in the following extreme conditions :

- Extremely dusty or humid places.
  - Extremely hot or cold places (operating temperature -5°C to +45°C).
  - Close to generators of powerful electromagnetic radiation such as radio or TV transmitters.
  - Places subject to fluorescent light reflections.
  - Places subject to unstable (flickering, etc.) lighting conditions.
  - Places subject to strong vibration.
- 
- Remove dust or dirt on the surface of the lens with a blower.
  - Do not apply excessive force or static electricity that could damage the camera.
  - Do not shoot direct images that are extremely bright (e.g., light source, sun, etc.), and when camera is not in use, put the lens cap on.
  - Confirm the mutual ground potential carefully and then connect the camera to monitors or computers. AC leaks from the connected devices may cause damages or destroy the camera.
  - Do not apply excessive voltage. (Use only the specified voltage.) Unstable or improper power supply voltage may cause damages or malfunction of the camera.
  - The voltage ripple of camera power DC +12V±10% shall be within ±50mV. Improper power supply voltage may cause noises on the video signals.
  - The rising time of camera power supply voltage shall be less than +10V, Max 60ms. Please avoid noises like chattering when rising.

### 3. Specification

#### 3.1.General Specification

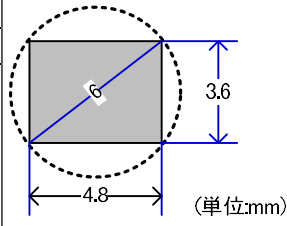
(1) Image Sensor	Type	Diagonal length 6.0mm Global Shutter (OnSemi AR0135)	
	Effective Pixel Number	1284(H) x 962(V)	
	Cell Size	3.75 $\mu$ m(H) x 3.75 $\mu$ m(V)	
	Image Circle	$\Phi$ 6.0mm (SXGA) $\Phi$ 3.0mm (VGA) $\Phi$ 1.5mm (QVGA)	
			
(2) Video Output Frequency	Pixel CLK	74.25MHz	
	Output effective pixel number	SXGA : 1284(H) x 962(V) VGA : 644(H) x 482(V) QVGA : 324(H) x 242(V)	
	USB3.0  USB2.0	SXGA : 54fps VGA : 105fps QVGA : 198fps  SXGA : 15 fps VGA : 29 fps QVGA : 55 fps	1388(H) x 989(V) : with Blanking 1388(H) x 509(V) : with Blanking 1388(H) x 269(V) : with Blanking 5000(H) x 989(V) : with Blanking 5000(H) x 509(V) : with Blanking 5000(H) x 269(V) : with Blanking
(3) Video Output	USB3.0/2.0 : UVC (YUV-RAW), Y8 (RAW)		
(4) Output Format	Sensor AD	12bit	
	USB3.0/2.0	8bit	
(5) Sensitivity	B/W	F8	2000lx
	Color	F5.6	2000lx
at shutter speed 1/54s(OFF), Gain 0dB			
(6) Minimum Illumination	B/W	F1.4	4lx
	Color	F1.4	8lx
at shutter speed 1/54s(OFF), Gain +12dB			
(7) Power Requirements	USB Bus Power : DC+5V $\pm$ 5%		
(8) Power Consumption	typ 0.9 W max 1.1 W		
(9) Dimensions	Normal : W:18.0mm D:46.5mm H:18.0mm excluding projection		
	L-angle : W:18.0mm D:19.15mm H:46.2mm excluding projection		
(10) Weights	Approx. 8g		
(11) Lens Mount	M12 Mount		
(12) Gain	0dB ~ +12dB		
(13) Shutter Speed	USB3.0 (Normal Mode) : OFF(1/54s) ~ 1/54000s		
	USB3.0 (Trigger Mode) : OFF(1/45s) ~ 1/45000s		
	USB2.0 : OFF(1/15s) ~ 1/15000s		
(14) Trigger Mode	Fixed Trigger Shutter Mode		
(15) Scan Mode	SXGA : Partial Scan 1/2, 1/4, 1/8 Binning : 2x2(VGA)		
	VGA : Partial Scan 1/2, 1/4, 1/8		
(16) Safety/ Quality Standards	CE	To be applied for EN61000-6-3:2007+A1:2011 for Emission	
		To be applied for EN61000-6-1:2007 for Immunity	
RoHS: Conform to RoHS			
(17) Durability	Vibration	20~200 Hz, 98m/s <sup>2</sup> (10G), X,Y and Z directions (120 min for each direction)	
	Shock	No malfunction shall be occurred with 980m/s <sup>2</sup> (100G) for $\pm$ X, $\pm$ Y, $\pm$ Z, 6 directions. (without package)	
(18) Environment	Operation	0 $^{\circ}$ C ~ +40 $^{\circ}$ C Humidity 0 ~ 90%RH	
	Storage	-25 $^{\circ}$ C ~ +65 $^{\circ}$ C Humidity 0 ~ 90%RH	

### 3.2. Camera Output Signal Specification

#### 3.2.1. USB3.0 / 2.0

(1) Video Output Data	Effective Video Output	1284(H) × 962(V)	
(2) Video Signals	White Clip Level	FFh	(at gain 0dB)
	Setup Level	Under 0Ch	
	Dark Sharding	Both horizontal and vertical should be under 00Fh	

#### 3.2.2. External Input / Output

(1) Trigger in	CN1 : 1pin	Low 1.4V(max), High 3.3V~5.0V	5.0V : USB bus power - 0.3V typ.
	Polarity	Positive	
(2) Exposure signal	CN1 : 3pin	No pull-up resistor	Max 30V (under 0.12W)
	Polarity	Positive / Negative	Address 0D

Trigger Input circuit

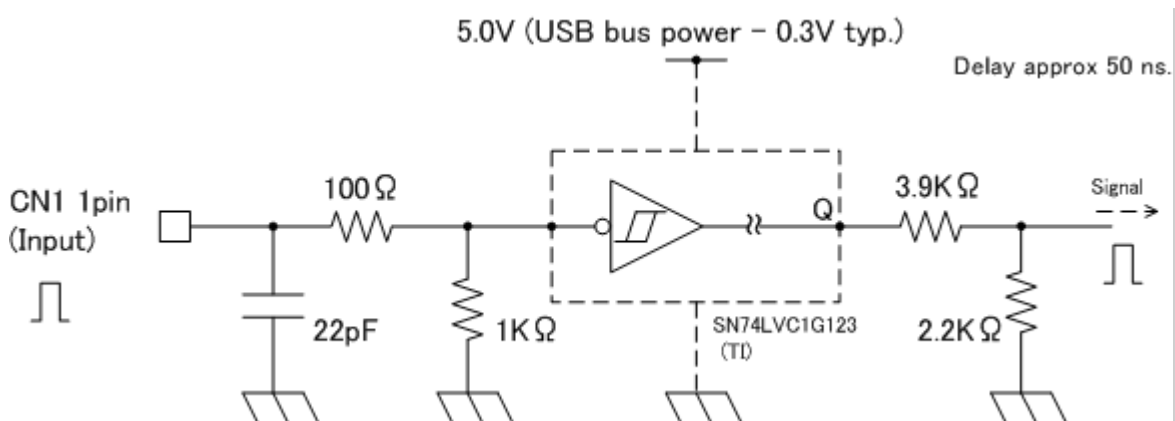

Exposure Output circuit

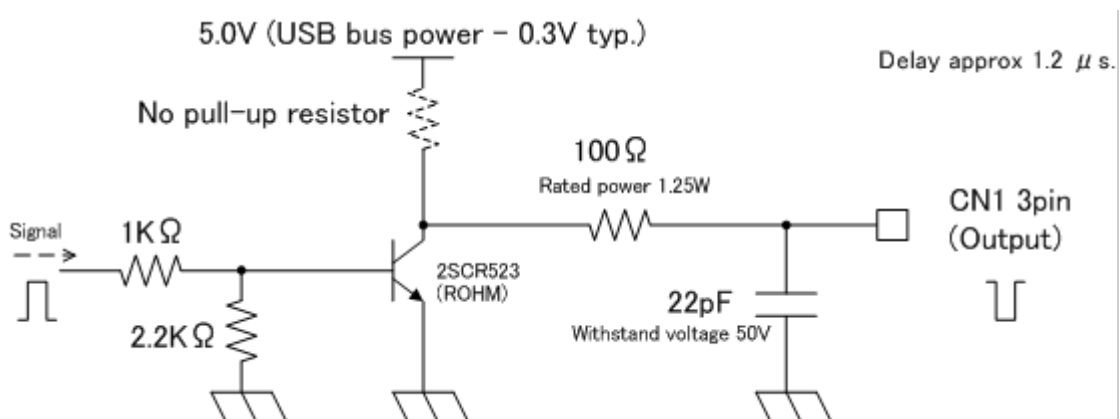

### 3.3.Spectral Response (Representative Value)

ID1MB-MDL-U (B/W)

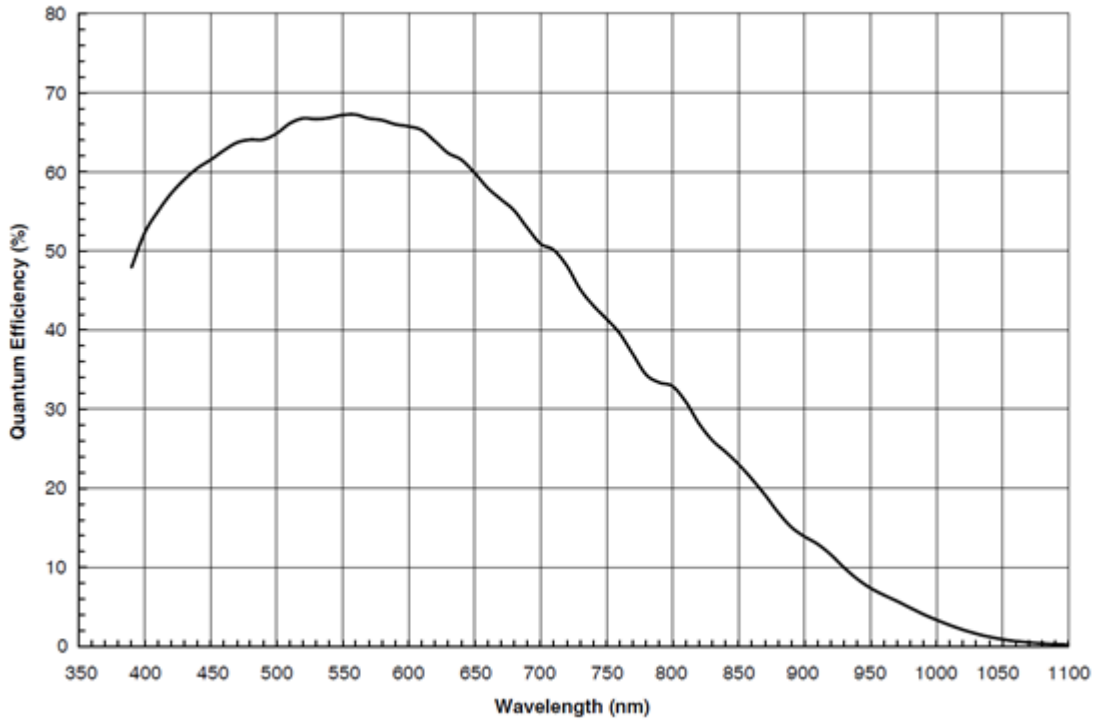

ID1MC-MDL-U (Color)

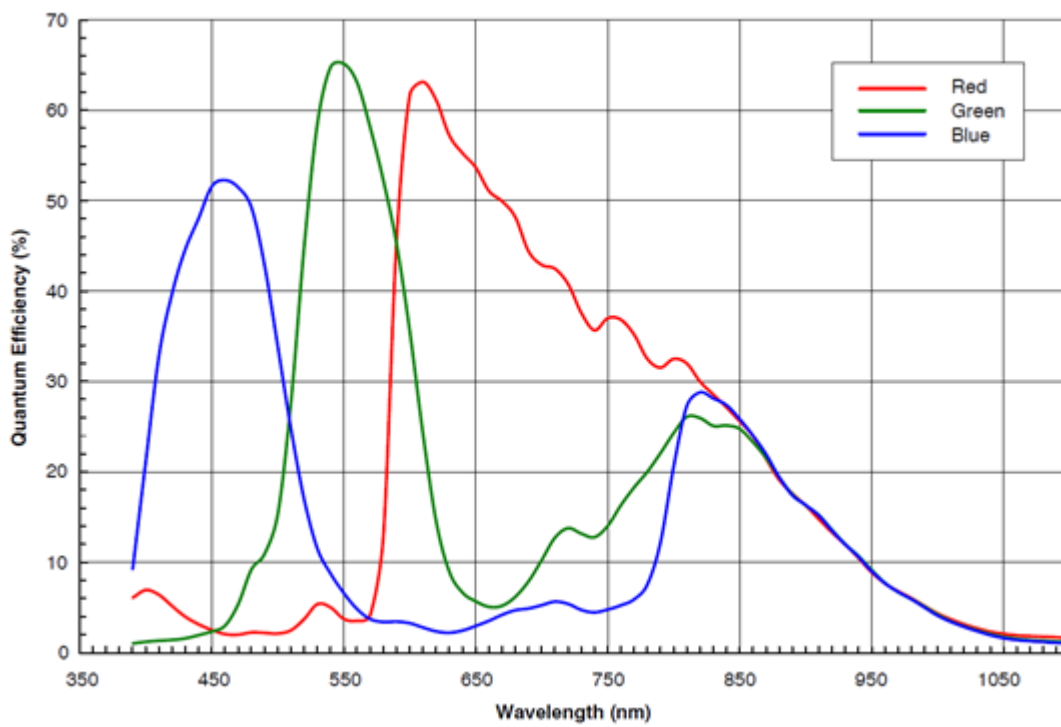

## 4. Connector

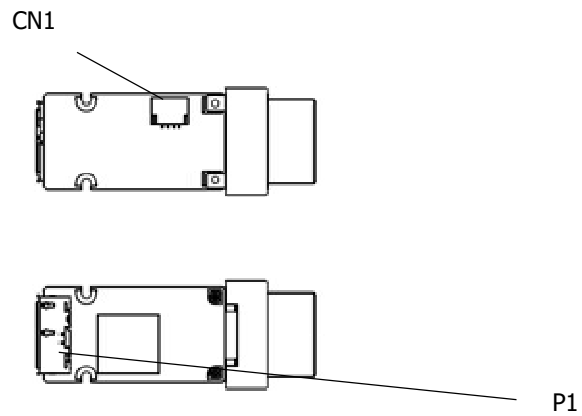

### 4.1. Connector P1

USB3.0 Micro B Connector  
USB Bus Power

### 4.2. Connector CN1

External input and output connector SM04B-SRSS-TB (JST)

PIN No	Name
1	Trigger IN
2	GND
3	Exposure OUT
4	GND

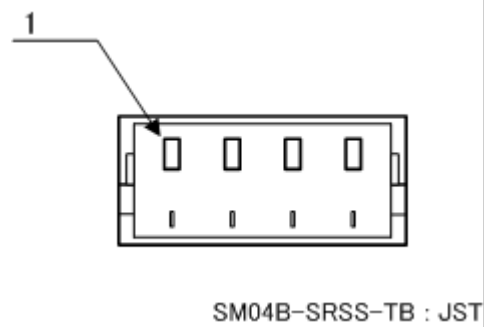

## 5. Timing Chart

### 5.1.USB3.0 Normal Shutter Mode

After CMOS sensor is finished to expose, start to translate USB data.

USB translate timing is not fixed.

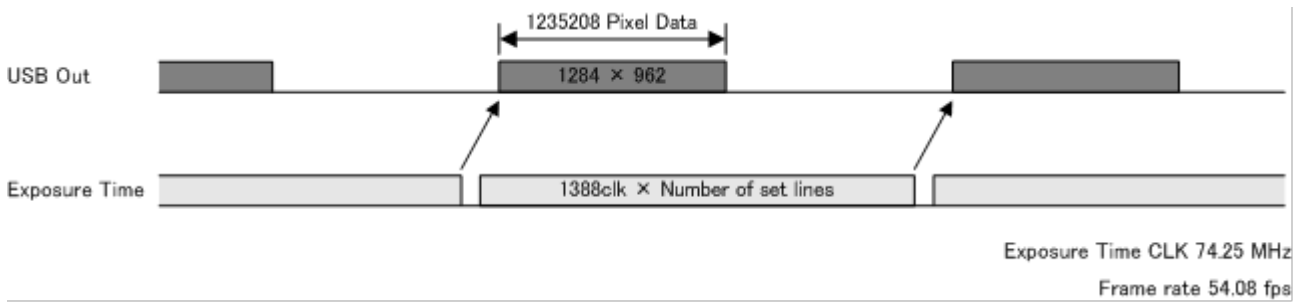

### 5.2. USB3.0 Fixed Trigger Shutter Mode

After CMOS sensor is finished to expose, start to translate USB data.

Frame Rate depend on trigger timing and exposure time.

USB translate timing is not fixed.

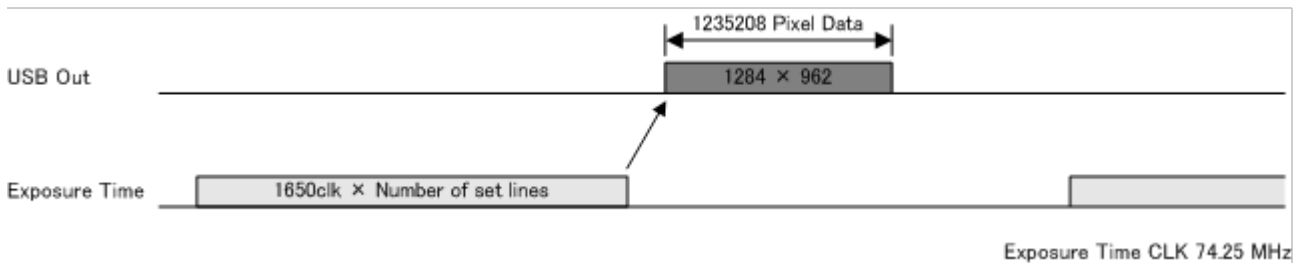



### 5.3.USB2.0 Normal Shutter Mode

TBD

After CMOS sensor is finished to expose, start to translate USB data.

USB translate timing is not fixed.

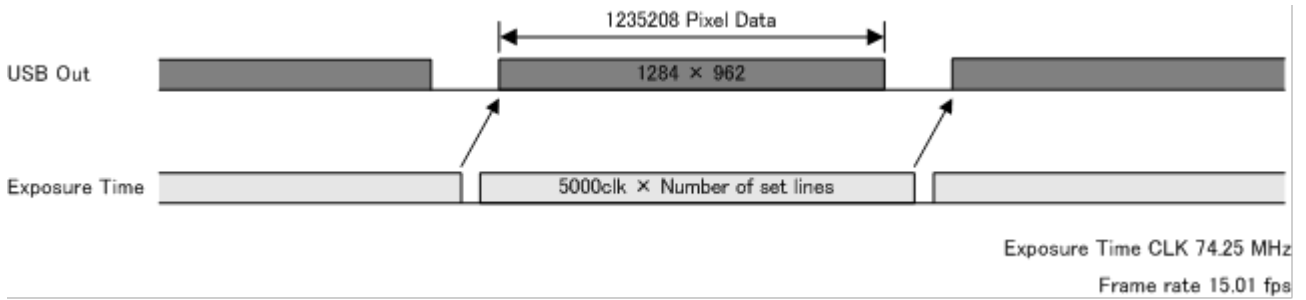

### 5.4.USB2.0 Fixed Trigger Shutter Mode

After CMOS sensor is finished to expose, start to translate USB data.

Frame Rate depend on trigger timing and exposure time.

USB translate timing is not fixed.

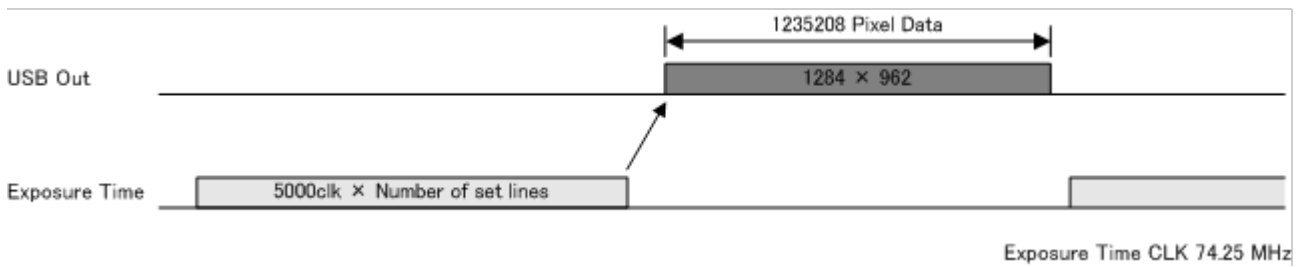

## 5.5. Output Format

UVC (YUV-RAW)  
ID1MB-MDL-U

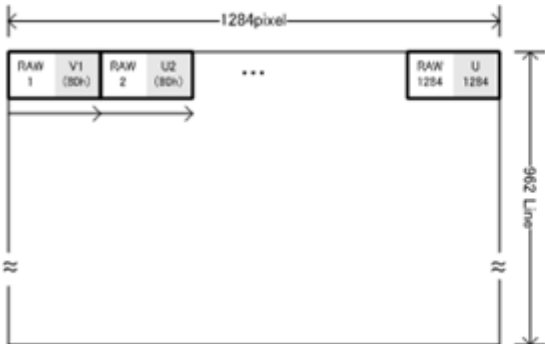

ID1MC-MDL-U

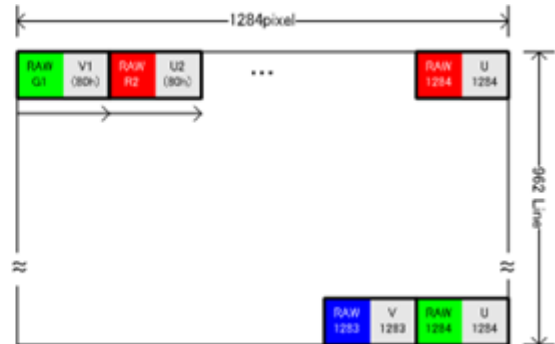

Y8 (RAW)  
ID1MB-MDL-U

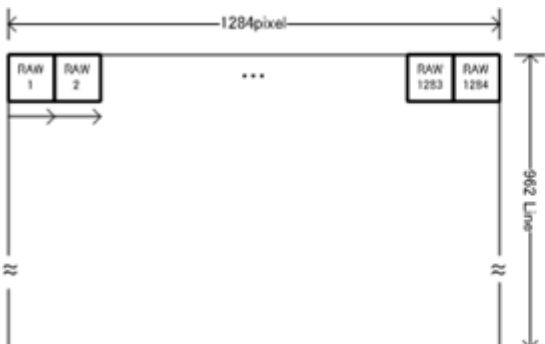

ID1MC-MDL-U

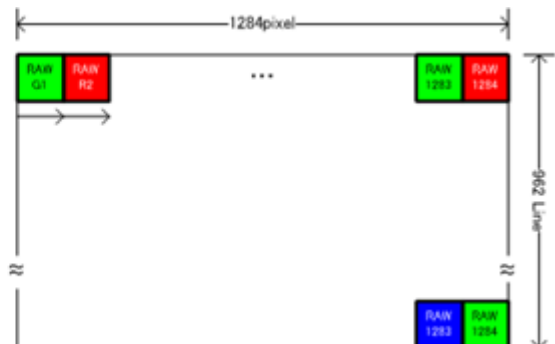

## 5.6.Fixed Trigger Shutter Mode

- This is the mode to start exposure with external input trigger signals, and set the exposure time with serial commands.
- Delay time (Exposure Time Delay) from detecting trigger edge in the camera to starting exposure is as below.

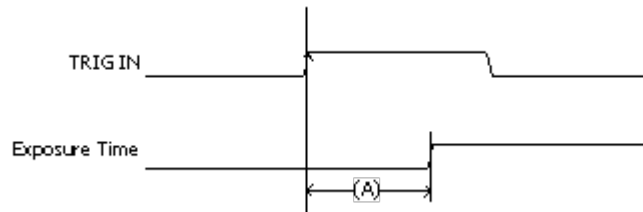

### Exposure Time Delay (A)

•USB3.0	188us	(8.5H)	1H=22.22us
•USB2.0	572us	(8.5H)	1H=67.34us

- Triggers cannot be accepted even when exposing and outputting video signals.  
Trigger input during exposure time should be ignored. (Refer to the below B and C)

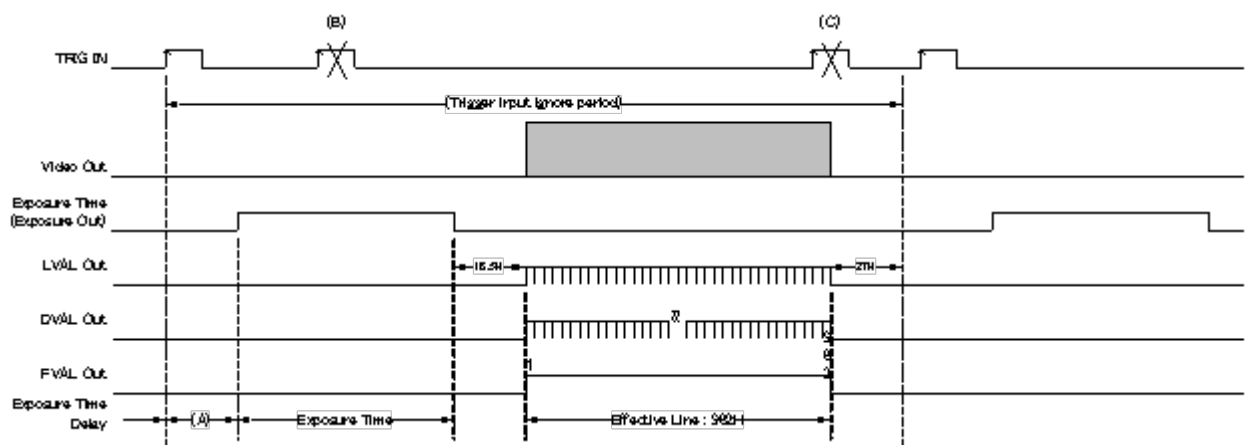



- Please set the start position  $2 \times n$ .

**Start position + Effective Line number  $\leq 962$**

- Flame Total Lines Time

Normal Shutter Mode

**= V blanking line number 27H fixed) + Partial Scan Effective line numbers**

Fixed Trigger Shutter Mode

**= Shutter Speed (s) + V blanking line number 54H fixed) + Partial Scan Effective line numbers**

- Frame Rate =  $1 / (\text{Total lines} \times \text{Time for 1 line})$

Time for 1 line =

USB3.0 :Normal Mode : 18.69us Fixed Trigger Shutter Mode : 22.22us

USB2.0 : 67.34us

- Normal Shutter Mode

Mode	Effective Line Number	Frame Rate (Total Line number)	
		USB3.0	USB2.0
VGA1/8	62H	601.05fps (89H)	166.8fps (89H)
1/8, VGA1/4	122H	359.02 (149)	99.6 (149)
1/4, VGA1/2 (QVGA Mode)	242H	198.8 (269)	55.2 (269)
1/2 (VGA Mode)	482H	105.09 (509)	29.1 (509)

- Fixed Trigger Shutter Mode Shutter Speed 1/1000s (45H)

Mode	Effective Line Numer	Shutter Speed Line Numer	Frame Rate (Total Shutter Line number)	
			USB3.0	USB2.0
VGA1/8	62H	45H	279.5fps (161H)	92.2fps (161H)
1/8, VGA1/4	122H	45H	203.6 (221)	67.1 (221)
1/4, VGA1/2 (QVGA)	242H	45H	131.9 (341)	43.5 (341)
1/2 (VGA)	482H	45H	77.4 (581)	25.5 (581)

## 7. Binning Mode

- Two horizontal pixels and two vertical pixels are added to one pixel for output.
- The number of pixels (transfer data amount) can be reduced without changing the angle of view.
- Frame rate is the same as all pixel output.
- Select 644 x 482 (VGA mode) in UVC Commit Control, and set the binning mode by communication command.

Binning Mode Address : 11 h

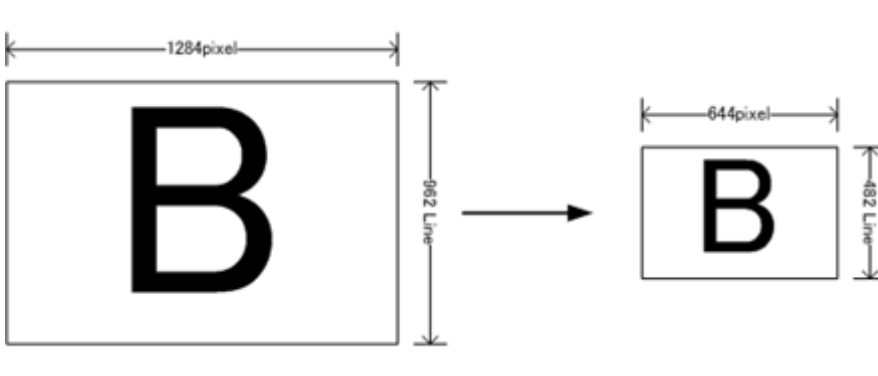

## 8. VGA Mode

- VGA mode 644 x 482 pixels are cut out from all pixels and output.
- There are fewer lines and the frame rate goes up to 88.4 fps.
- Select 644 x 482 in UVC Commit Control and set to VGA mode.
- The start position can be set by communication command for both horizontal and vertical.

Partial Scan

Horizontal Start Position Address : 42 – 43 h  
Vertical Start Position Address : 40 – 41 h

- Please set the start position  $2 \times n$ .

**Horizontal Start position +644 <= 1284**

**Vertical Start position +482 <= 962**

\*The data FFFF h (initial value) is the center position (320,240).

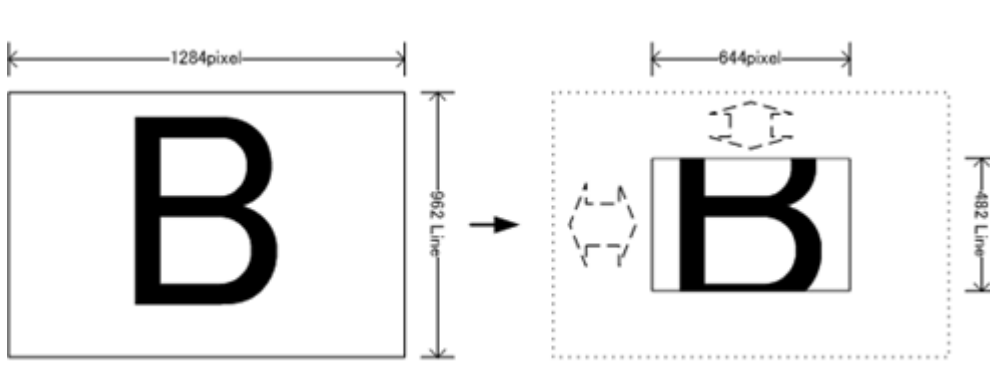

## 9. QVGA Mode

- Cut out QVGA 324 x 242 pixels from all pixels and output.
- There are fewer lines and the frame rate goes up to 167.28fps.
- Select 324 x 242 in UVC Commit Control and set to QVGA mode.
- The start position can be set by communication command for both horizontal and vertical.

### Partial Scan

Horizontal Start Position      Address : 42 – 43 h  
Vertical Start Position          Address : 40 – 41 h

- Please set the start position  $2 \times n$ .

**Horizontal Start position +324 <= 1284**

**Vertical Start position +242 <= 962**

\*The data FFFF h (initial value) is the center position (480,360).

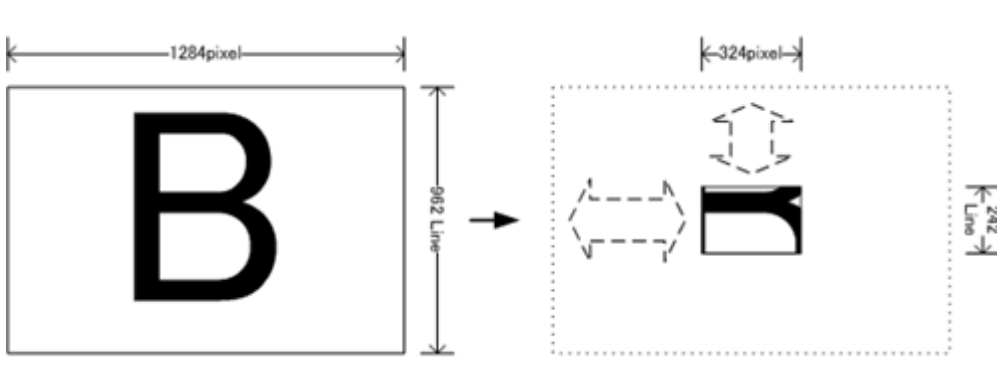

## 10. UVC Extension Units (USB) Function

Set the function with the SetVal () and GetVal () functions in the software development kit.

## 11. Function Setting

Function	Address (Hex)	Data(Hex)			
Gain Mode	00	00:	0dB		
		01:	6dB		
		02:	12dB		
		03:	Manual (Address20-21)		
		04:	RGB Manual Gain (* 1) (R Address 28-29, B Address2 A-2B, G Address 2C-2D) Gain setting is possible for each RGB.		
Shutter Mode	01		USB3.0 Normal Shutter Mode	USB3.0 Fixed Trigger Shutter Mode	USB2.0
		00:	1/54s(OFF)	1/45s(OFF)	1/15s(OFF)
		01:	1/75s	1/75s	1/30s
		02:	1/100s	1/100s	1/45s
		03:	1/150s	1/150s	1/75s
		04:	1/350s	1/350s	1/100s
		05:	1/500s	1/500s	1/150s
		06:	1/1000s	1/1000s	1/350s
		07:	1/2500s	1/2500s	1/500s
		08:	1/5000s	1/5000s	1/1000s
		09:	1/7500s	1/7500s	1/2500s
		0A:	1/10500s	1/9000s	1/3000s
		0B:	1/13000s	1/11250s	1/3700s
		0C:	1/18000s	1/15000s	1/5000s
		0D:	1/54000s	1/45000s	1/15000s
0E:	1/54000s	1/45000s	1/15000s		
0F:	Manual (Address24-25)				
Trigger Shutter Mode	04	00:	Normal Shutter Mode (Trigger OFF)		
		01:	Fixed Trigger Shutter Mode (Address 01)		
Trigger Input	06	00:	CN1		
		01:	Soft trigger		
Output Mode (* 2)	0A	00:	UVC YUV-RAW		
		01:	Y8 RAW		
		02:	UVC YUV-RAW		
		03:	Y8 RAW (Original Format : for Windows)		



Function	Address (Hex)	Data(Hex)	
USB Mode	0C	00:	Auto USB3.0 / 2.0 is automatically detected and an image is output.
		01:	USB3.0 fixed
		02:	USB2.0 fixed
Exposure Signal	0D	00:	Positive
		01:	Negative
		02:	Low fixed
		03:	High fixed
Binning Mode	11	00:	OFF
		01:	ON UVC Commit Control ( VGA Mode: ON)
Manual Gain	20-21	LLHH:	min:0(0H) - max:144(90H) Gain Step 0.020833 (x1 = 0.20833 x 48) Gain (x) = (48 + Setting Value) x 0.020833 0: x1(0dB), 48: x2(+6dB), 144: x4(+12dB)
Manual Shutter	24-25	LLHH:	min:0(0H) - max:984(3D8H)  USB3.0 Normal Shutter mode Shutter speed time = (985 – setting value) x 18.69us min:0= 18.41ms (1/54s) , max:984 = 18.69us (1/54000s)  USB3.0 Fixed trigger shutter mode Shutter speed time = (985 – setting value) x 22.22us min:0= 21.89ms (1/45s) , max:984 = 22.22us (1/45000s)  USB2.0 Shutter speed time = (985 – setting value) x 67.34us min:0= 66.33ms (1/15s) , max:984 = 67.34us (1/15000s)  * Only when the setting value is 983, it becomes an exception and does not apply to the above formula, Exposure time is the same as max value 984.
R Manual Gain (* 1)	28-29	LLHH:	min:0(0H) - max:144(90H) Gain step 0.020833 (x1 = 0.20833 x 48) Gain (x) = (48 + Setting value) x 0.020833 0: x1(0dB), 48: x2(+6dB), 144: x4(+12dB)
B Manual Gain (* 1)	2A-2B	LLHH:	min:0(0H) - max:144(90H) 0: x1(0dB), 48: x2(+6dB), 144: x4(+12dB)
G Manual Gain (* 1)	2C-2D	LLHH:	min:0(0H) - max:144(90H) 0: x1(0dB), 48: x2(+6dB), 144: x4(+12dB)

Function	Address (Hex)	Data(Hex)	
Vertical Start Position	40-41	LLHH:	UVC Commit Control Partial Scan / VGA / QVGA Mode min:0(0H) - max:900(384H)
Horizontal Start Position	42-43	LLHH:	UVC Commit Control VGA Mode / QVGA Mode min:0(0H) - max:960(3C0H)

## 12. Dimensions

L-angle : ID1MB/C-MDL(L)-U

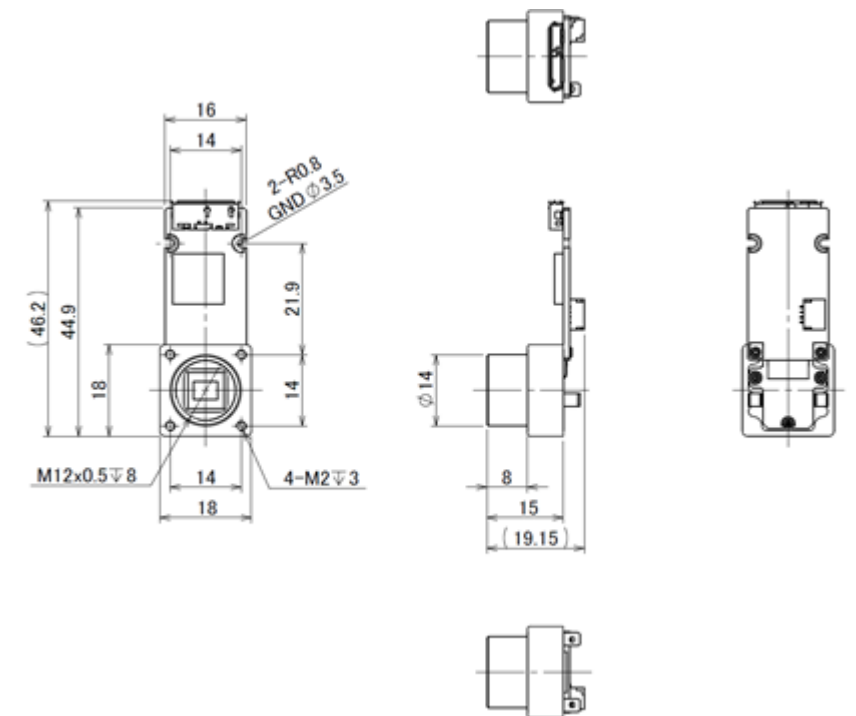

(mm)

---

---

### 13. Initial Setting

Function	Address	Data	
Gain Mode	00	00:	0dB
Shutter Mode	01	00:	(OFF) *1
Trigger Mode	04	00:	Normal (Trigger OFF)
Trigger Input	06	00:	CN1
Camera Output Mode	0A	00:	UVC YUV-RAW
USB Mode	0C	00:	Auto
Exposure Signal	0D	01:	Negative
Binning Mode	11	00:	OFF
Manual Gain	20-21	0000:	0dB
Manual Shutter	24-23	0000:	Shutter(OFF)
Manual White Balance R (Color model)	28-29	0000:	0dB
Manual White Balance G (Color model)	2A-2B	0000:	0dB
Manual White Balance B (Color model)	2C-2D	0000:	0dB
Vertical Start Position	40-41	FFFF:	Center Position
Horizontal Start Position	50-51	FFFF:	Center Position

\* 1 USB3.0 Normal Shutter Mode : 1/54s, USB3.0 Fixed Trigger Shutter Mode : 1/45s, USB2.0 : 1/15s

---

---

#### 14. **Cases for Indemnity (Limited Warranty)**

We shall be exempted from taking responsibility and held harmless for damage or losses incurred by the user in the following cases.

- In case damage or losses are caused by fire, earthquake, or other acts of God, acts by third party, deliberate or accidental misuse by the user, or use under extreme operating conditions.
- In case indirect, additional, consequential damages (loss of business interests, suspension of business activities) are incurred as result of malfunction or non-function of the equipment, we shall be exempted from responsibility for such damages.
- In case damage or losses are caused by failure to observe the information contained in the instructions in this product specification & operation manual.
- In case damage or losses are caused by use contrary to the instructions in this product specification & operation manual.
- In case damage or losses are caused by malfunction or other problems resulting from use of equipment or software that is not specified.
- In case damage or losses are caused by repair or modification conducted by the customer or any unauthorized third party (such as an unauthorized service representative).

#### 15. **CMOS Pixel Defect**

IDULE compensates the noticeable CMOS pixel defects found at the shipping inspection prior to our shipment. On very rare occasions, however, CMOS pixel defects might be noted with time of usage of the products.

Cause of the CMOS pixel defects is the characteristic phenomenon of CMOS itself and IDULE is exempted from taking any responsibilities for them. Should you have any questions on CMOS pixel defects compensation, please contact us.

#### 16. **Product Support**

When defects or malfunction of our products occur, and if you would like us to investigate on the cause and repair, please contact your distributors you purchased from to consult and coordinate.