

LTS-3LINH300

		产品型号	LTS-3LINH300
		LED发光色	R(红)/W(白)
单位	mm (毫米)	输入电压	DC 24V(max)
比例	1:1	消耗功率	/
版本	NO 1.8	电缆极性	1:+、2:-、3:FAN+、4:FAN-

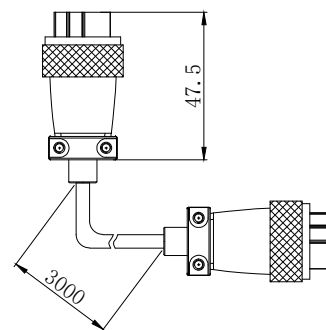
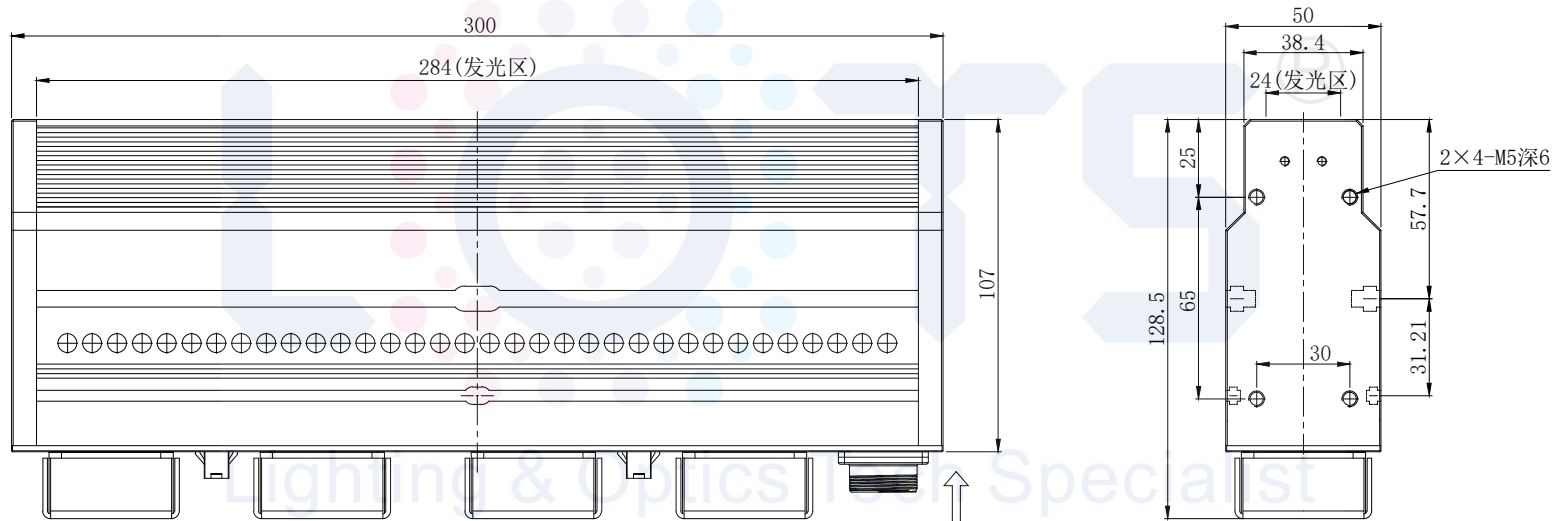
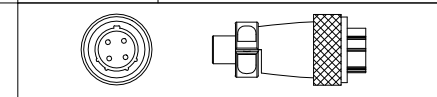

注: 两侧有M3和M5的螺母卡槽用于安装。